

Adroit[™] DV245 (Integral CO₂ Sensor)

Instruction Manual



Adroit® DV245

(Integral CO₂ Sensor)

Adroit[®] DV245 (Integral CO₂ Sensor)

CONTENTS

1. INTRODUCTION	4
<ul style="list-style-type: none"> • The main parts of the ventilation unit • System description • General safety instructions • Adroit Digital Controller • Starting up and shutting down the unit 	
2. DEPLOYMENT WIZARD	9
<ul style="list-style-type: none"> • Basic settings (setting the language, time and date) • Expert settings (setting the password and access rights, parental controls, fan settings, profile settings) 	
3. USING THE UNIT	19
<ul style="list-style-type: none"> • Ventilation profiles • Temperatures and sensors • Settings (filter, display settings, time and date, Week clock, turning the unit off) 	
4. MAINTENANCE	38
<ul style="list-style-type: none"> • Filters • Heat recovery cell • Fans • Troubleshooting • Condensing water 	
5. INSTALLATION	43
<ul style="list-style-type: none"> • Installing the condensing water outlets • Measuring tubes 	
6. TECHNICAL SPECIFICATIONS	44
<ul style="list-style-type: none"> • Technical data, supply/extract air volumes, fan curves, sound values, main components, measurement points, dimensions and duct outlets • Internal electrical connection • External electrical connection • Heating and cooling radiator operation charts 	
7. EXPLODED VIEW AND PARTS LIST	51
8. CERTIFICATE OF CONFORMITY	52
9. USER LEVEL DIAGRAMS	53
10. COMMISSIONING THE SYSTEM	54
11. WARRANTY	54



NOTE:









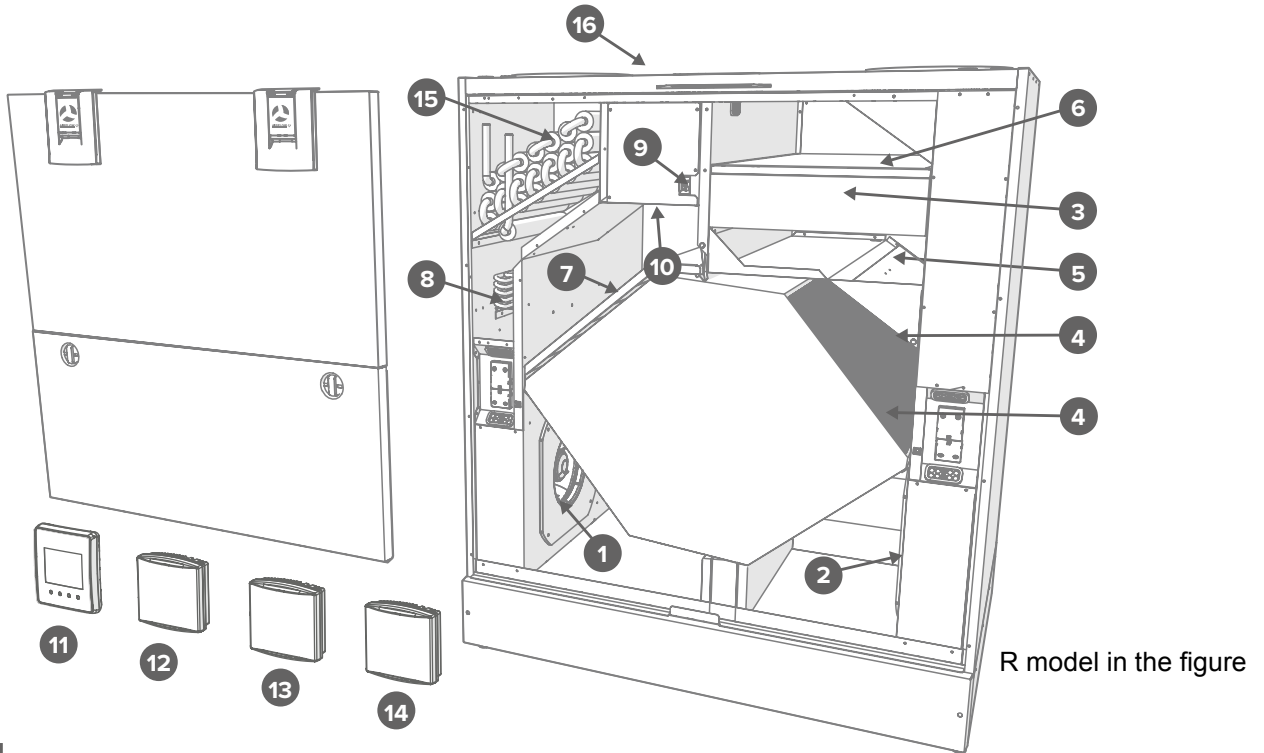







You can sign into your Adroit account at: www.airflowadroitcontrol.com

Adroit® DV245 (Integral CO₂ Sensor)

INTRODUCTION

MAIN PARTS OF THE VENTILATION UNIT



- | | | | | |
|---|-------------------------------|---|---|---|
|  | Supply air fan | 1 | | |
|  | Extract air fan | 2 |  | Internal humidity sensor (behind the electric box) 10 |
|  | Fine filter for supply air | 3 |  | Internal carbon dioxide sensor (behind the electric box) 10 |
|  | Heat recovery cell, 2 pcs | 4 |  | Digital Controller 11 |
|  | Bypass damper of the HR cell | 5 |  | Carbon dioxide sensor (optional) 12 |
|  | Coarse filter for supply air | 6 |  | Humidity sensor (optional) 13 |
|  | Coarse filter for extract air | 7 |  | VOC sensor (Optional) 14 |
|  | Post-heating resistor | 8 |  | Post-heating liquid radiator 15 |
|  | Safety switch | 9 |  | Cable gland 16 |

Adroit® DV245 (Integral CO₂ Sensor)

INTRODUCTION

SYSTEM DESCRIPTION

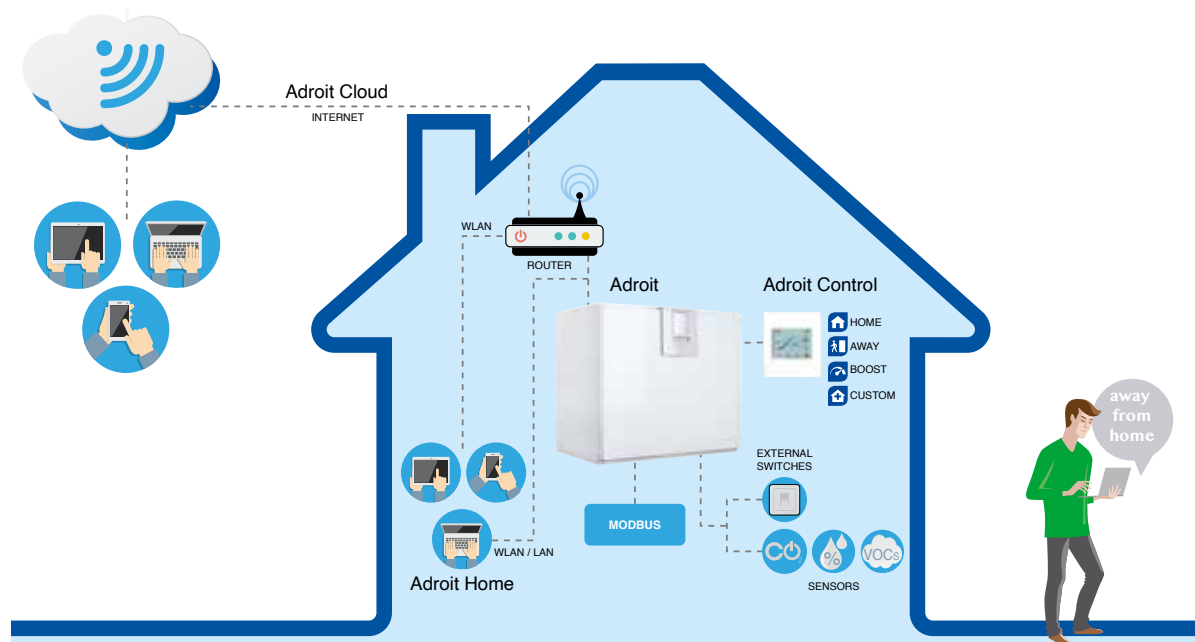

CONNECTING WITH ADROIT HOME

1. Connect Adroit unit to the mains.
2. Connect one end of the network cable (RJ-45) to computer and the other end to network connector on the Adroit unit.
3. Select on your computer: Start → Computer → Network
4. Double click on the Airflow icon.
5. Now you are connected to the Adroit Home service, you are able to control the Adroit unit.

REGISTERING TO THE ADROIT CLOUD

1. Connect with Adroit Home (instruction above).
2. Select Settings.
3. Press connect button in Adroit Cloud Service section.
4. Registration Page is now opened.
5. Enter the following information
 - a. Device name- enter the desired name for the device
 - b. User name
 - c. E-mail address
 - d. Password
6. Press the create account button.
7. An e-mail with your log-in details will be sent to the e-mail given during the registration process.
8. A verification e-mail will be sent to the e-mail address given during the registration process.
9. Click on the link given in this e-mail to verify your e-mail address.
10. You are now connected to the Adroit Cloud.



NOTE

The Adroit unit can also be connected by network cable to a router. In this case the Adroit unit can be controlled via your laptop, tablet, smartphone etc using a network created by the router.



NOTE

Following requirements:
 Firefox, version 31 or higher
 Opera, version 25 or higher
 Chrome, version 31 or higher
 Safari, version 7 or higher
 The latest browser versions on mobile devices.

Adroit® DV245

(Integral CO₂ Sensor)

INTRODUCTION

GENERAL SAFETY INSTRUCTIONS

For safe and proper handling, it is necessary to know the basic safety regulations and the intended usage of the ventilation system. Read this manual before operating the ventilation unit. Keep this manual for later use. In case of loss, you can download the manual from our website.

This user manual contains all important tips for operating the system safely. This user manual must be observed by all persons who operate and maintain the ventilation system. Furthermore, observe all local accident prevention regulations.

INTENDED USE

All Adroit ventilation units have been designed to provide appropriate and continuous ventilation in such a way that people and structures will remain healthy.

INSTALLATION

















Installation and setup should be carried out only by competent person. Electrical installations and connections must be carried out only by an electrician and in compliance with local regulations.

Adroit[®] DV245 (Integral CO₂ Sensor)

INTRODUCTION

ADROIT DIGITAL CONTROLLER

Note: Option description can be set by the button below the displayed image.

DISPLAYED IMAGE	OPTION DESCRIPTION
	Change profile. Allows you to scroll through the ventilation profiles.
	Profile Information. Allows you to view the currently active profile information.
	Temperature. Displays information on temperatures and sensors.
	Settings. Opens individual settings.
	Back. Takes you backwards in the menu.
	Left arrow. Allows you to scroll to the left through the menu settings.
	Right arrow. Allows you to scroll to the right through the menu settings.
	OK. Allows you to accept the selected option.
	Select. Allows you to select an option from the shown menu.
	Edit. Allows you to edit settings.
	Plus. Allows you to: Increase the value of the selected setting. Move to the next menu item. Move from a one-day view to a week view in the temperature, relative humidity of air and carbon dioxide level graphs.
	Minus. Allows you to: Reduce the value of the selected setting. Return to the previous menu item. Move from a week view to a one-day view in the temperature, relative humidity of air and carbon dioxide level graphs.
	Up arrow. Allows you to scroll upwards in the menu.
	Down arrow. Allows you to scroll downwards in the menu.
	Statistics. Allows you to open the temperature, relative humidity of air and carbon dioxide level graphs (1 day or 1 week).
	Indicate the chosen user level.
	Indicates when the feature is locked at your user level. The parental controls lock code is 1001.

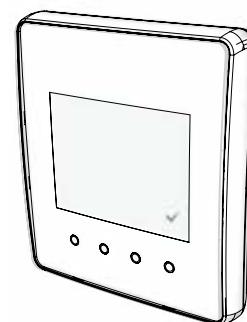

NOTE

The Adroit Digital Controller contains the buttons described in the following table. You can press the graphical user interface buttons by using the ring-shaped buttons below the controller. The controller does not have a touch screen.

Adroit® DV245 (Integral CO₂ Sensor)

INTRODUCTION

INTRODUCTION

Ventilation has to be constant for the indoor air to stay healthy for the dwellers and the structures of the dwelling. Even for longer holidays, it is not advisable to stop the ventilation, because the indoor air will become stuffy and during the heating season, the indoor air humidity may condense in the ventilation ductwork and structures, causing moisture damage.

You can control and automate the ventilation unit operation in the following ways:

- By using a controller installed in the building
- Through the Home local network connection and the Web interface
- Through the Adroit Cloud Service and the Web interface
- Through a remote monitoring service or building automation by using voltage signals or Modbus messages

The required ventilation may also be adjusted automatically with the optional carbon dioxide and humidity sensors. In this case, ventilation remains optimal even if the dwelling is unoccupied.

By using the Week clock you can create just the right ventilation for your individual lifestyle.

The following settings will be configured during the setup of the ventilation system:

- user interface language
- time and date
- system administrator password
- parental controls, if turned on
- fan settings
- user profile settings, such as the temperature.

The qualified ventilation installer must complete the fan settings in accordance with the ventilation plan. Do not change these settings.

STARTING THE UNIT

If you are starting the ventilation unit for the first time or after a maintenance procedure, first connect it to the mains. During the start-up, the diagnostics display will appear for a few seconds, after which the main display of the At home profile opens.

If the ventilation unit was turned off from the controller (see Turning the Unit Off), you can start it by pressing any controller's button.



WARNING

The unit is not intended for use by children under 8 or by persons with reduced sensory, physical or mental capabilities or whose lack of knowledge and experience do not ensure safe operation of the unit.

Such persons can use the unit under supervision or by following the instructions of someone who is responsible for their safety.



TIP

Adroit Digital Controller automatically switches to the sleep mode when the **Sleep time set in the display settings has elapsed**. You can wake up the controller by pressing any controller's button.



NOTE

The first starting of the unit may take a while, because of the software version check.

Adroit[®] DV245 (Integral CO₂ Sensor)

BASIC SETTINGS

SWITCHING THE UNIT OFF

If you want to switch off the ventilation unit, proceed as follows:

1. Select **Settings** > Turn unit **OFF**.
2. Press the **OK** button.
3. The system asks for confirmation.
4. Press the **OK** button.
5. The ventilation unit is now switched off.



NOTE

However, it is recommended that the ventilation be kept turned on without disruptions.



NOTE

The first launch of the unit may take a while, as the controller will format its software and verify that it has the latest software version.

UPDATING THE UNIT SOFTWARE

Disconnect the ventilation unit from the mains electrical supply or turn off the fuse. Connect the computer to the digital controller of the ventilation unit using a USB MicroB connector.

Start the ventilation unit. A USB sign will appear on the display of the controller. The controller cannot be used when it is connected to the computer. Transfer the update file you have downloaded onto the ventilation unit. Copy the update file HSWUPD.BIN

(Please note! Do not alter the file name!) you have downloaded at the root of the controller (the controller will be displayed on your computer as a mass memory or a removable disk drive). When the file has uploaded onto the controller, remove the USB cable.

Next, the controller will take a while to load the update. The controller will now start to load the update file onto the motherboard. This can take several hours. The controller will remain turned on, but it is recommended that the controller will not be used during that time.

When the update is ready, the unit will restart automatically.

Adroit[®] DV245 (Integral CO₂ Sensor)

BASIC SETTINGS

DEPLOYMENT WIZARD

1. Start the Adroit ventilation unit.
2. Press the **OK** button.
3. The deployment wizard is launched.

SELECTING THE LANGUAGE

Select the user interface language as follows:

1. Use the arrow buttons to select the language.
2. Select **OK**.
3. The language has now been set and the controller will move on to the time settings.



SET THE TIME

When the deployment wizard prompts you to set the date and time, the Time and date screen is opened first:

1. Use the **Plus** and **Minus** buttons to set the hours.
2. Press the **Right arrow** button.
3. Use the **Plus** and **Minus** buttons to set the minutes.
4. The time is now set.
5. Proceed to the next phase by pressing the **Right arrow** button.

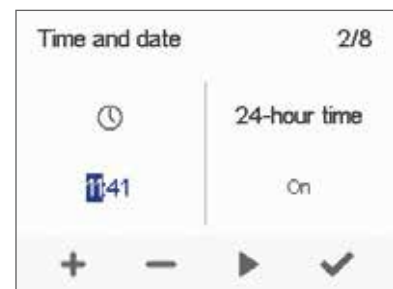

SET THE 24- OR 12-HOUR CLOCK

By default, the system uses the **24** hour clock.

If you want to use the **24** hour clock, proceed to the next step by pressing the Right arrow button.

If you want to use the **12** hour clock, proceed as follows:

1. Press the **Minus** button. The **24 Hour Time** setting value is changed to **Off**.
2. Proceed to the next phase by pressing the **Right arrow** button.

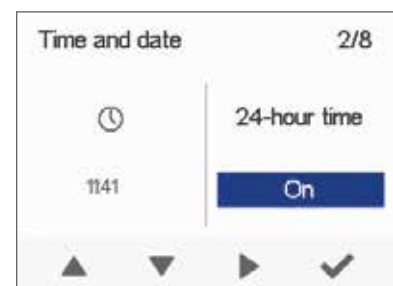

Adroit[®] DV245 (Integral CO₂ Sensor)

BASIC SETTINGS

SET THE AUTOMATIC DAYLIGHT SAVING TIME

By default, the system automatically switches to the summer time. If you want to use the automatic daylight saving time, proceed to the next step by pressing the Right arrow button. If you want to use the manual daylight saving time, proceed as follows:

1. Press the **Minus** button. The Daylight saving time setting value is changed to **Off**.
2. The manual daylight saving time setting is now set.
3. Proceed to the next phase by pressing the **Right arrow** button.

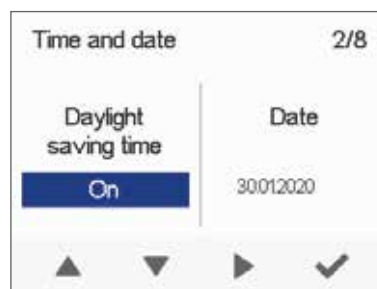

SET THE DATE

1. Use the **Plus** and **Minus** buttons to set the date.
2. Press the **Right arrow** button.
3. Use the **Plus** and **Minus** buttons to set the month.
4. Press the **Right arrow** button.
5. Use the **Plus** and **Minus** buttons to set the year.
6. Press the **OK** button:
7. The date is now set.

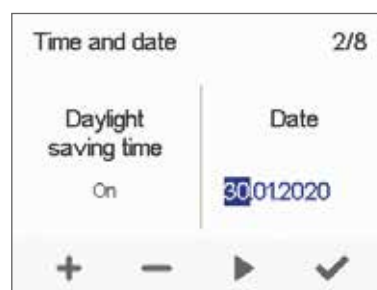

FINISHING UP THE DEPLOYMENT

When the basic settings have been completed, the acknowledgement screen is opened.

If you want to continue and make the advanced settings for the ventilation unit, press the **OK** button.

If you do not wish to proceed with the advanced settings and use the ventilation device on factory settings, press the **Back** button: Expert settings for the ventilation device can be installed at a later date when required.

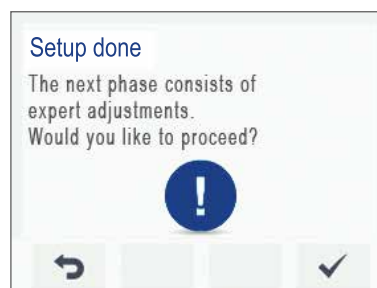

EXPERT SETTINGS

The following sections describe the ventilation device deployment wizard phase, where you activate the expert settings.



IMPORTANT

Some deployment phases require special equipment, such as an air flow meter.

Adroit[®] DV245 (Integral CO₂ Sensor)

EXPERT SETTINGS

PASSWORD AND ACCESS LEVEL

Once you have finished up the basic settings, the deployment wizard moves on to setting the system password.



NOTE

If you set the password as 0000, the password inquiry is not used.

1. The deployment wizard Password and access level screen is opened.
2. Set the first digit of the password by using the **Up arrow** and **Down arrow** buttons. Proceed to the next digit by pressing the **Right arrow** button.
3. Set the second, third and fourth digit in the same manner as the first digit.
4. Press the **OK** button.
5. The password is now set.



ENTER THE NEW PASSWORD HERE:



USER LEVEL

There are three user levels:

- **Extensive** — At the extensive user level, the user can access every menu on the controller.
- **Normal** — At the normal user level, the user's access to some menus is restricted.
- **Limited** — At the limited user level, the user has access only to the basic functions of the ventilation units.

For more information on user levels, see section 9, User level diagrams. If you want to set the system user level, proceed as follows:

1. The deployment wizard User level screen is opened.
2. Use the **Plus** and **Minus** buttons to set the user level.
3. Press the **Right arrow** button.
4. The user level is now set.



PARENTAL CONTROLS

Parental control locks the digital controller, protecting the units settings. If you want to set the system child lock, proceed as follows:

1. The deployment wizard Password and access level screen is opened.
2. Set the parental controls on or off by using the **Plus** and **Minus** buttons.
3. Press the **OK** button.
4. The parental controls are now set.

PARENTAL CONTROLS ACCESS CODE:



Adroit[®] DV245 (Integral CO₂ Sensor)

EXPERT SETTINGS

FAN SETTINGS

The following sections describe how to set the output ratio between the supply and extract air fans.

IMPORTANT

Adjust the air flows, according to the values in the ventilation design. Try to adjust the air flows in a way that you do not have to choke the air flows at the valves. This is the most energy efficient set up.

First, set both supply and extract values as close to the ideal value as possible. The ideal values are presented in the supply and extract air volume graphs. If, at the beginning, the air flows differ greatly from the designed rate, check the air flows by measuring them at the valves and adjust the airflow rates if necessary by first adjusting the units fans, then by adjusting the room valves.

NOTE

If the outside air is extremely cold (below -3°C on a plastic cell), the ventilation device may have to defrost the heat exchanger cell. If this occurs, you cannot adjust the air flows and the **Defrosting** figure is shown on the controller.

SUPPLY AIR

If you want to set the system supply air settings, proceed as follows:

1. The deployment wizard Fan settings screen is opened.
2. Set the supply air quantity as a percentage of the maximum output ratio by using the **Plus** and **Minus** buttons. The fan speed (1/min) will change, according to the percentage value.
3. Once you have set the supply air fan settings, press the **Right arrow** button.

EXTRACT AIR

If you want to set the system extract air settings, proceed as follows:

1. The deployment wizard Fan settings screen is opened.
2. Set the extract air quantity as a percentage of the maximum output ratio by using the **Plus** and **Minus** buttons. The fan speed (1/min) will change, according to the percentage value.
3. Press the **OK** button.
4. The extract air fan speed is now set.

WARNING

The ventilation specialist has set the supply and exhaust air settings when deploying the ventilation unit. If you make changes to the settings, ensure that they conform with the ventilation design to ensure the system still complies with Building Regulations.

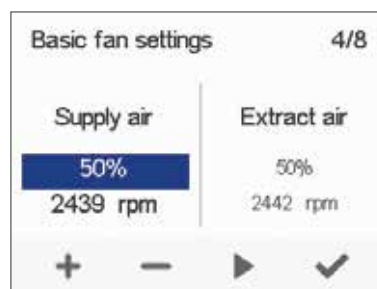
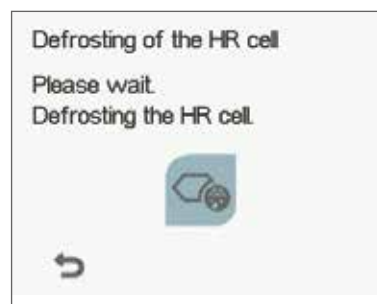

Adroit® DV245 (Integral CO₂ Sensor)

EXPERT SETTINGS

PROFILE SETTINGS

In the following sections you can make ventilation settings for the system profiles.

AT HOME PROFILE

If you want to set the **At home** profile settings, proceed as follows:

1. The deployment wizard **At home** screen will open.



NOTE

When the units fans have been set (step 5 in the deployment wizard) these values will default to the **At home** profile fan speed value. We recommend this basic amount of ventilation for the **At home**

profile setting. If necessary, you can change it.

2. Set the **At Home** profile fan speed as a percentage of the maximum output ratio by using the **Plus** and **Minus** buttons.
3. The **At Home** profile fan speed value is now set.
4. Press the **Right arrow** button.
5. The temperature setup screen is opened.
6. Set the desired supply air temperature for the **At Home** profile by using the **Plus** and **Minus** buttons. You can adjust the temperature in the range of +10°C – +5°C.
7. The At home profile supply air temperature is now set.
8. Press the **Right arrow** button.
9. The setup screen for the automatic fan speed control, based on the relative humidity, appears.
10. Use the **Plus** and **Minus** buttons to select whether the automatic fan speed control, based on the relative humidity, is used or not.
11. The automatic fan speed control, based on the relative humidity, is now set.
12. Press the **Right arrow** button.
13. The setup screen for the automatic fan speed control, based on the carbon dioxide or VOC content, appears.
14. Use the **Plus** and **Minus** buttons to select whether the automatic fan speed control, based on the carbon dioxide or VOC content, is used or not.
15. The automatic fan speed control, based on the carbon dioxide or VOC content, is now set.
16. Press the **OK** button.

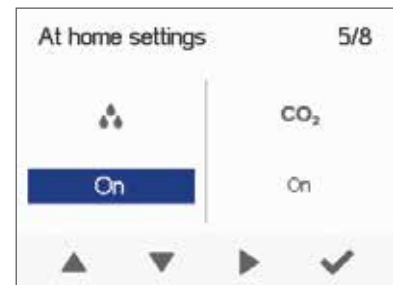
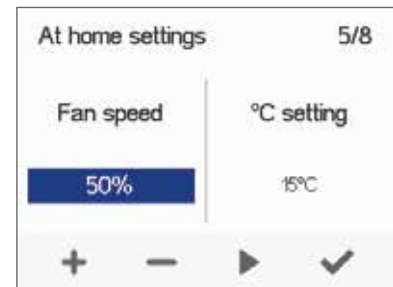

NOTE

You can browse the settings of the At home profile with the **Right arrow** button.

Adroit[®] DV245 (Integral CO₂ Sensor)

EXPERT SETTINGS

AWAY PROFILE

If you want to set the **Away** profile settings, proceed as follows:

1. The deployment wizard **Away** profile screen is opened.



NOTE

Once you have set the fan speed for the **At home** profile, the fan speed for the **Away** profile will default to -30% of the **At home** profile fan speed. We recommend this basic amount of ventilation for the **Away** profile setting. If necessary, you can change it.

2. Set the **Away** profile fan speed as a percentage of the maximum output ratio by using the **Plus** and **Minus** buttons.
3. The **Away** profile fan speed value is now set.
4. Press the **Right arrow** button.
5. The temperature setup screen is opened.
6. Set the desired supply air temperature for the **Away** profile by using the **Plus** and **Minus** buttons. You can adjust the temperature in the range of +10°C – +5°C.
7. The **Away** profile supply air temperature is now set.
8. Press the **Right arrow** button.
9. The setup screen for automatic fan speed control, based on the relative humidity, appears.
10. Use the **Plus** and **Minus** buttons to select whether the automatic fan speed control, based on the relative humidity, is used or not.
11. The automatic fan speed control, based on the relative humidity, is now set.
12. Press the **Right arrow** button.
13. The setup screen for the automatic fan speed control, based on the carbon dioxide or VOC content, appears.
14. Use the **Plus** and **Minus** buttons to select whether the automatic fan speed control, based on the carbon dioxide or VOC content, is used or not.
15. The automatic fan speed control, based on the carbon dioxide or VOC content, is now set.
16. Press the **OK** button.



Adroit® DV245 (Integral CO₂ Sensor)

EXPERT SETTINGS

BOOST PROFILE

If you want to set the **Boost** profile settings, proceed as follows:

1. The deployment wizard **Boost** profile screen is opened.



NOTE

Once you have set the fan speed for the **At home** profile, the fan speed for the **Boost** profile will default to +30% of the At home profile fan speed. We recommend this basic amount of ventilation for the **Boost** profile setting. If necessary, you can change it.

2. Set the **Boost** profile fan speed as a percentage of the maximum output ratio by using the **Plus** and **Minus** buttons.
3. Press the **Right arrow** button.
4. The temperature setup screen is opened.
5. Set the desired supply air temperature for the **Boost** profile by using the **Plus** and **Minus** buttons. You can adjust the temperature in the range of +10°C – +5°C.
6. Press the **Right arrow** button.
7. The setup screen for the automatic fan speed control, based on the relative humidity, appears.
8. Use the **Plus** and **Minus** buttons to select whether the automatic fan speed control, based on the relative humidity, is used or not.
9. Press the **Right arrow** button.
10. The setup screen for the automatic fan speed control, based on the carbon dioxide or VOC content, appears.
11. Use the **Plus** and **Minus** buttons to select whether the automatic fan speed control, based on the carbon dioxide or VOC content, is used or not.
12. Press the **Right arrow** button.
13. The profile timer setting screen is displayed.
14. Use the **Plus** and **Minus** buttons to select whether the profile timer function is enabled or not. The options are:
 - **On** — When the timer is enabled, the **Boost** profile is only on for the period defined in the timer.
 - **Off** — When the timer is disabled, the **Boost** profile is used until you (or the Week clock) change the profile.
15. Press the **Right arrow** button.
16. The timer duration setting screen appears.
17. Set the profile timer duration in minutes by using the **Plus** and **Minus** buttons.
18. Press the **OK** button.

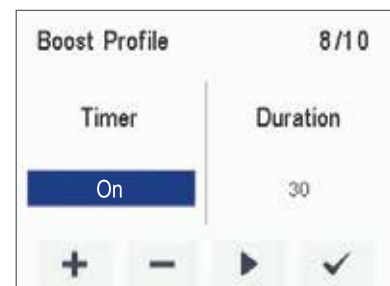
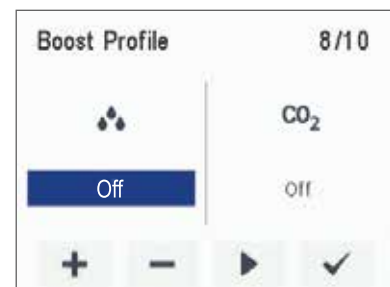
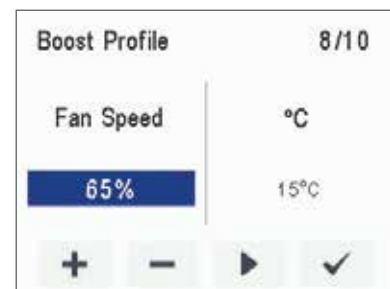

Adroit[®] DV245 (Integral CO₂ Sensor)

EXPERT SETTINGS

CUSTOM PROFILE

If you want to set the **Custom** function settings, proceed as follows:

1. The deployment wizard **Custom** function profile screen is opened.
2. Set the profile timer duration in minutes by using the **Plus** and **Minus** buttons.
3. The profile duration is now set.
4. Press the **Right arrow** button.
5. The screen for setting the profile supply air fan speed appears.
6. Set the **Custom** function supply air fan speed as a percentage of the maximum output ratio by using the **Plus** and **Minus** buttons.

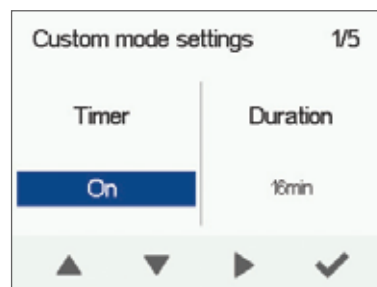

i TIP

In the Custom mode, we recommend that you increase the supply air fan speed in order to obtain a positive pressure at the ventilation zone. We do not recommend reducing the extract air fan speed.

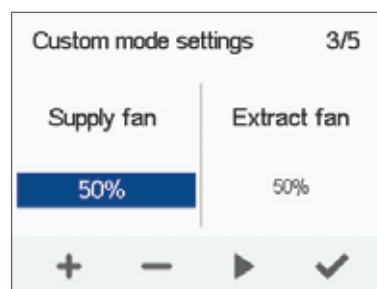

7. The **Custom function** supply air fan speed is now set.
8. Press the **Right arrow** button.
9. The screen for setting the profile extract air fan speed appears.
10. Set the **Custom function** extract air fan speed as a percentage of the maximum output ratio by using the **Plus** and **Minus** buttons.

11. The **Custom function** extract air fan speed is now set.
12. Press the **Right arrow** button.
13. The profile timer setting screen is displayed.
14. Use the **Plus** and **Minus** buttons to select whether the profile timer function is enabled or not. The options are:
 - **On** — When the timer is enabled, the **Custom function** is only on for the period defined in the timer.
 - **Off** — When the timer is disabled, the **Custom function** is used until you (or the Week clock) change the profile.
15. The profile timer function is now set.
16. Press the **OK** button.
17. The **Custom function** settings are now complete.

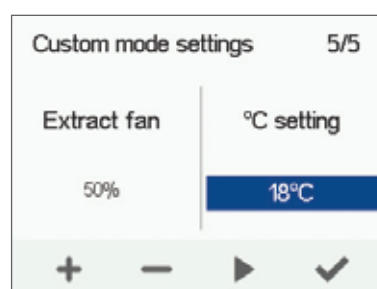

Adroit® DV245 (Integral CO₂ Sensor)

EXPERT SETTINGS

FINISHING UP

When you have completed the wizard, the Setup done screen will open.

Finish up the deployment as follows:

1. If you want to go back to repair or change a value, use the arrow buttons to select the desired line and press the **OK** button.
2. Repeat the selected setup phase or phases until you are satisfied with the settings.
3. When you are satisfied with the settings, use the arrow buttons to select Start and press the **OK** button.

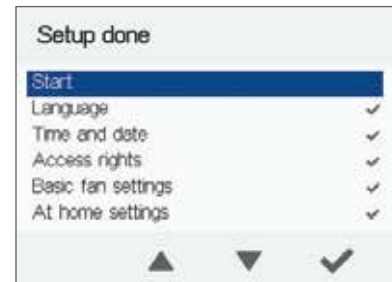

Adroit® DV245 (Integral CO₂ Sensor)

VENTILATION PROFILES

THE VENTILATION UNIT HAS FOUR VENTILATION PROFILES:



AT HOME

Use this ventilation profile when the dwelling or the premises are occupied



AWAY

Use this ventilation profile when the dwelling or premises are unoccupied, e.g. during a trip or other long absence.



BOOST

Use this profile to increase the ventilation rate, e.g. when there are more people than usual in the dwelling or local ventilation regulations dictate.



CUSTOM

Use this ventilation profile when, for example, you are making a fire in the fireplace. This profile is primarily used to create momentary overpressure in the dwelling to help elevate back spillage into the room.

SYMBOLS FOR VENTILATION PROFILES

The following symbols are used on the main displays of the profiles:
Table 2. Profile symbols

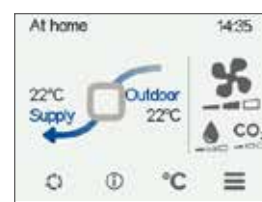

SYMBOL	DESCRIPTION
	The mode in use is either At home, Away, or Boost. The Week clock is turned off.
	The mode in use is either At home, Away, or Boost. The Week clock is on.
	The mode in use is Custom. The Week clock might be turned on.
	The mode in use is either At home, Away, or Boost. The programmable input has become activated.
	These fan symbols indicate the currently used mode. <ul style="list-style-type: none"> Fan and one shaded bar — The Away mode is in use. Fan and two shaded bars — The At home mode is in use. Fan and three shaded bars — The Boost mode is in use.
	Droplet symbols indicate the relative humidity of air. <ul style="list-style-type: none"> Droplet and one shaded bar — A humidity sensor has been installed and the relative humidity of air is normal. Droplet and two shaded bars — The relative humidity of air is slightly higher than normal. Ventilation efficiency needs to be boosted. When the automatic fan speed control is based on the relative humidity of the air, ventilation is automatically boosted. Droplet and three shaded bars — The relative humidity of air is significantly higher than normal. The fan speed will be automatically increased if automatic adjustment has been chosen.
	CO ₂ symbols indicate the carbon dioxide or the VOC level in the air. <ul style="list-style-type: none"> CO₂ and one shaded bar - The carbon dioxide or VOC sensor has been installed and the level is normal. CO₂ and two shaded bars - The carbon dioxide or VOC level is slightly higher than normal. The fan speed will be automatically increased if automatic adjustment has been chosen. CO₂ and three shaded bars - The carbon dioxide or VOC level is significantly higher than normal. The fan speed will be automatically increased if automatic adjustment has been chosen.

Adroit® DV245 (Integral CO₂ Sensor)

VENTILATION PROFILES

CHANGING THE PROFILE

If you want to change the ventilation profile, proceed as follows:

1. Press the **Change profile** button until the desired ventilation profile icon appears on the display.
2. Wait until the main display of the ventilation profile appears.
3. The ventilation profile will now be changed.



VIEWING VENTILATION PROFILE INFORMATION

VIEWING THE AT HOME PROFILE INFORMATION

If you want to view the **At home** profile settings, proceed as follows:

1. Open the **At home** profile main view.
2. Press the **Profile information** button.
3. The first information screen for the profile appears.

This screen contains the following information:

- **Supply air** — Indicates the temperature of the air blown to in to the property and its set value shown in brackets, if the supply air is warmer than the set value.
 - **Outdoor air** — Indicates the outdoor air temperature.
 - **Fan speed** — Indicates the fan speed. If the automatic fan speed **boost** is turned on, the set value is shown in brackets first followed by the actual fan speed.
 - **Heat recovery cell status** — Indicates the status of the ventilation unit heat recovery cell. The status options are:
 - **Heat recovery** — The heat recovery cell heats the air streaming in from outdoors.
 - **Cooling** — The heat recovery cell cools the air streaming in from outdoors.
 - **Cell bypass** — The inflowing air bypasses the heat recovery cell.
 - **Defrosting** — The heat recovery cell is being defrosted.
4. Press the **Right arrow** button.
 5. The second information screen for the profile appears.

This screen contains the following information:

- **Humidity** — Indicates the highest relative humidity of air measured by the extract air sensor.
- **Carbon dioxide** — Indicates the highest carbon dioxide level measured by the extract air sensor.
- **Change filters** — Indicates the next recommended filter change date.
- **Days in use** — Indicates how long the unit has been running in days and years.

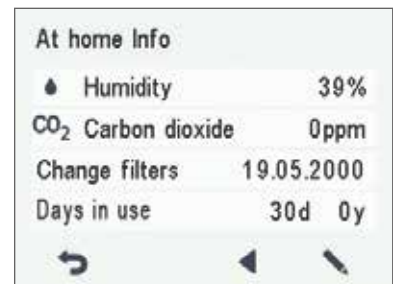
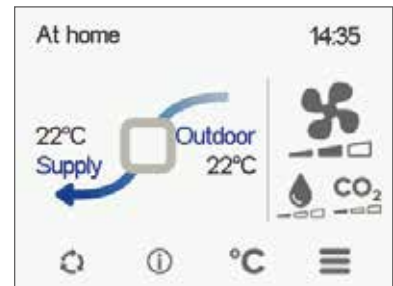

Adroit[®] DV245 (Integral CO₂ Sensor)

VENTILATION PROFILES

VIEWING THE AWAY PROFILE INFORMATION

If you want to view the Away profile settings, proceed as follows:

1. Open the **Away** profile main view.
2. Press the **Profile information** button.
3. The first information screen for the profile appears.

This screen contains the following information:

- **Supply air** — Indicates the temperature of the air blown in to the property and its set value shown in brackets, if the supply air is warmer than the set value.
- **Outdoor air** — Indicates the outdoor air temperature.
- **Fan speed** — Indicates the fan speed. If the automatic fan speed **boost** is turned on, the set value is shown in brackets first followed by the actual fan speed.
- **Heat recovery cell status** — Indicates the status of the ventilation unit heat recovery cell. Possible statuses are:
 - **Heat recovery** — The heat recovery cell heats the air streaming in from outdoors.
 - **Cooling** — The heat recovery cell cools the air streaming in from outdoors.
 - **Cell bypass** — The inflowing air by-passes the heat recovery cell.
 - **Defrosting** — The heat recovery cell is being defrosted.

4. Press the **Right arrow** button.
5. The second information display for the profile opens.

This screen contains the following information:

- **Humidity** — Indicates the highest relative humidity of air measured by the extract air sensor.
- **Carbon dioxide** — Indicates the highest carbon dioxide level measured by the extract air sensor.
- **Change filters** — Indicates the next recommended filter change date.
- **Days in use** — Indicates how long the unit has been running in days and years..

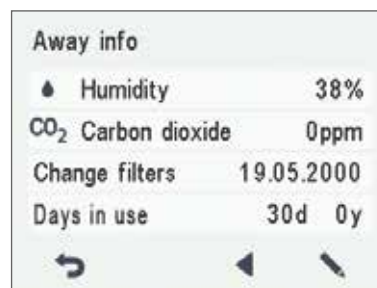

Adroit® DV245 (Integral CO₂ Sensor)

VENTILATION PROFILES

VIEWING THE BOOST PROFILE INFORMATION

To view the **Boost profile** settings, proceed as follows:

1. Open the **Boost** profile main view.
2. Press the **Profile information** button.
3. The first information screen for the profile is opened.

This screen contains the following information:

- **Supply air** — Indicates the temperature of the air blown in to the property and its set value shown in brackets, if the supply air is warmer than the set value.
- **Outdoor air** — Indicates the outdoor air temperature.
- **Fan speed** — Indicates the fan speed. If the automatic fan speed **boost** is turned on, the set value is shown in brackets first followed by the actual fan speed.
- **Heat recovery cell status** — Indicates the status of the ventilation unit heat recovery cell. Possible statuses are:
 - **Heat recovery** — The heat recovery cell heats the air streaming in from outdoors.
 - **Cooling** — The heat recovery cell cools the air streaming in from outdoors.
 - **Cell bypass** — The inflowing air bypasses the heat recovery cell.
 - **Defrosting** — The heat recovery cell is being defrosted.

4. Press the **Right arrow** button.
5. The second information display for the profile opens.

This display shows the following information:

- **Humidity** — Indicates the highest relative humidity of air measured by the extract air sensor.
- **Carbon dioxide** — Indicates the highest carbon dioxide level measured by the extract air sensor.
- **Change filters** — Indicates the next recommended filter change date.
- **Days in use** — Indicates how long the unit has been running in days and years.

Boost info	
Supply air	(15°C) 21°C
Outdoor air	8°C
Fan speed	30%
Cell status	Heat recovery

Boost info	
Humidity	37%
CO ₂ Carbon dioxide	0ppm
Change filters	19.05.2000
Days in use	30d 0y

VIEWING THE CUSTOM PROFILE INFORMATION

If you want to view the Custom function settings, proceed as follows:

1. Open the **Custom function** main view.
2. The profile main screen contains a summary of the profile data. Also see Table 2, "Profile symbols."

Adroit® DV245 (Integral CO₂ Sensor)

VENTILATION PROFILES

3. Press the **Profile information** button.
4. The first information screen for the profile opens. This screen shows the following information:
 - **Duration** — Indicates the duration of enhanced ventilation when the **Custom profile** is activated. The value is shown in hours and minutes.
 - **Remaining** - Indicates the remaining duration of the Custom profile.
 - **Supply fan speed** — Indicates the percentage of the supply air fan speed relative to the maximum speed.
 - **Extract fan speed** — Indicates the percentage of the extract air fan speed relative to the maximum speed.

Custom mode info	1/2
Duration	15min
Remaining	15min
Supply air fan	50%
Extract air fan	50%

MODIFYING THE PROFILE SETTINGS

! IMPORTANT

The system uses, but does not save the settings automatically. Your settings may be lost during, for example, a power cut. Remember to save your settings by selecting Expert settings > Save and restore settings.

MODIFYING THE AT HOME PROFILE SETTINGS

1. Open the **At home** profile main view.
2. Press the **Profile information** button.
3. Press the **Edit** button.
4. The fan speed setup screen is opened.
5. Set the **At home** profile fan speed as a percentage of the maximum output ratio by using the **Plus** and **Minus** buttons.
6. Press the **Right arrow** button.
7. The temperature setup screen is opened.
8. Set the desired supply air temperature for the **At home** profile by using the **Plus** and **Minus** buttons. You can adjust the temperature in the range +10°C ... +5°C. The recommended temperature is +15°C or 2—3°C below the room temperature.
9. Press the **Right arrow** button.
10. The setup screen for the automatic fan speed control, based on the relative humidity, appears.
11. Use the **Plus** and **Minus** buttons to select whether the automatic fan speed control, based on the relative humidity, is used or not.
12. Press the **Right arrow** button.
13. The setup for automatic fan speed control based on the carbon dioxide or VOC level opens.
14. Use the **Plus** and **Minus** buttons to select whether the automatic fan speed control, based on the carbon dioxide or VOC level, is used or not.
15. Press the **OK** button.

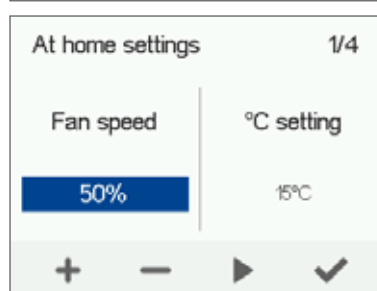

Adroit® DV245

(Integral CO₂ Sensor)

VENTILATION PROFILES

MODIFYING THE AWAY PROFILE SETTINGS



1. Open the **Away** profile main view.
2. Press the **Profile information** button.
3. Press the **Edit** button.
4. The fan speed setup opens.
5. Set the **Away** profile fan speed as a percentage of the maximum output ratio by using the **Plus** and **Minus** buttons.
6. Press the **Right arrow** button.
7. The temperature setup screen is opened.
8. Set the desired supply air temperature for the **Away** profile by using the **Plus** and **Minus** buttons. You can adjust the temperature in the range +10°C ... +5°C. The recommended temperature is +15°C or 2—3°C below the room temperature.
9. Press the **Right arrow** button.
10. The setup screen for automatic fan speed control, based on the relative humidity, appears.
11. Use the **Plus** and **Minus** buttons to select whether the automatic fan speed control, based on the relative humidity, is used or not.
12. Press the **Right arrow** button.
13. The setup for automatic fan speed control based on the carbon dioxide or VOC level opens.
14. Use the **Plus** and **Minus** buttons to select whether the automatic fan speed control, based on the carbon dioxide or VOC level, is used or not.
15. Press the **OK** button.

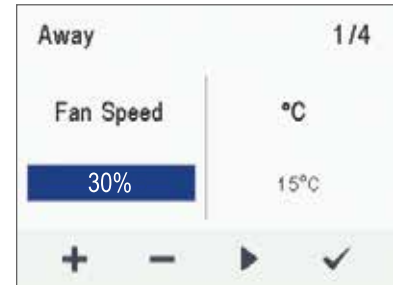

Adroit® DV245 (Integral CO₂ Sensor)

VENTILATION PROFILES

MODIFYING THE BOOST PROFILE SETTINGS

If you want to edit the Boost profile settings, proceed as follows:



1. Open **Boost** profile main view.
2. Press the **Profile information** button.
3. Press the **Edit** button.
4. The fan speed setup opens.
5. Set the Boost profile fan speed as a percentage of the maximum output ratio by using the **Plus** and **Minus** buttons.
6. Press the **Right arrow** button.
7. The temperature setup screen is opened.
8. Set the desired supply air temperature for the **Boost** profile by using the **Plus** and **Minus** buttons. The recommended temperature is +15°C or 2—3°C below the room temperature. You can adjust the temperature in the range of +10°C – +5°C.
9. Press the **Right arrow** button.
10. The setup screen for the automatic fan speed control, based on the relative humidity, appears.
11. Use the **Plus** and **Minus** buttons to select whether the automatic fan speed control, based on the relative humidity, is used or not.
12. Press the **Right arrow** button.
13. The setup for automatic fan speed control based on the carbon dioxide or VOC level opens.
14. Use the **Plus** and **Minus** buttons to select whether the automatic fan speed control, based on the carbon dioxide or VOC level, is used or not.
15. Press the **Right arrow** button.
16. The profile timer setting screen is opened.
17. Use the **Plus** and **Minus** buttons to select whether the profile timer function is used or not. The options are:
 - **On** — When the timer is on, the **Boost** profile is used only for the period specified in the timer.
 - **Off** — When the timer is off, the **Boost** profile is used until manually changed (or the Week clock) or the profile is changed.
18. Press the **Right arrow** button.
19. The profile timer duration setting screen is opened.
20. Set the profile timer duration by using the **Plus** and **Minus** buttons.
21. Press the **OK** button.

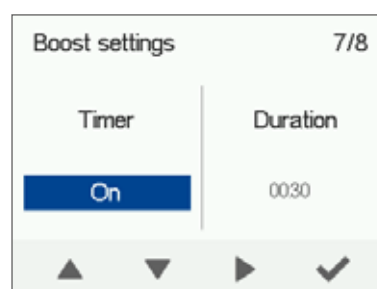
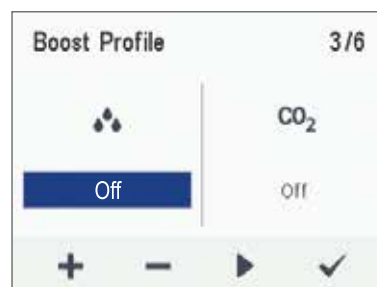
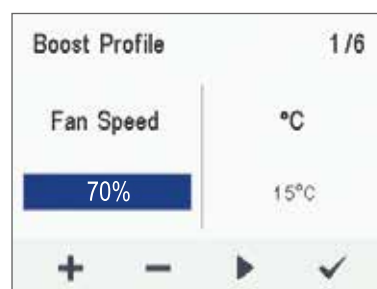

Adroit® DV245 (Integral CO₂ Sensor)

VENTILATION PROFILES

MODIFYING THE CUSTOM PROFILE SETTINGS

If you want to edit the Custom function settings, proceed as follows:

1. Open the **Custom function** main view.
2. Press the **Profile information** button.
3. Press the **Edit** button.
4. The fan speed setup screen is opened.
5. Use the **Plus** and **Minus** buttons to set the **Custom function** duration in minutes. This value determines how long the profile is enabled when you switch it on.
6. Press the **Right arrow** button.
7. The screen for setting the profile supply air fan speed appears.
8. Set the **Custom function** supply air fan speed as a percentage of the maximum output ratio by using the **Plus** and **Minus** buttons.



TIP

In the Custom mode, we recommend that you increase the supply air fan speed, in order to obtain a positive pressure at the ventilation zone. We do not recommend reducing the extract air fan speed.

9. Press the **Right arrow** button.
10. The screen for setting the profile extract air fan speed will appear.
11. Set the **Custom function** extract air fan speed as a percentage of the maximum output ratio by using the **Plus** and **Minus** buttons.
12. Press the **Right arrow** button.
13. The profile timer setting screen is displayed.
14. Use the **Plus** and **Minus** buttons to select whether the profile timer function is enabled or not. The options are:
 - **On** — When the timer is enabled, the **Custom function** is only on for the period defined in the timer.
 - **Off** — When the timer is disabled, the **Custom function** is used until manually changed (or the Week clock) or the profile is changed.
15. Press the **OK** button.

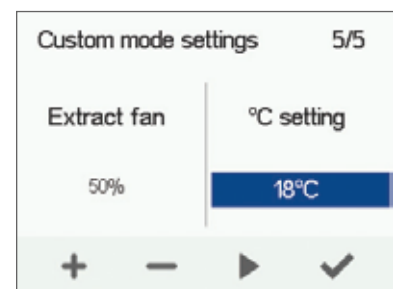
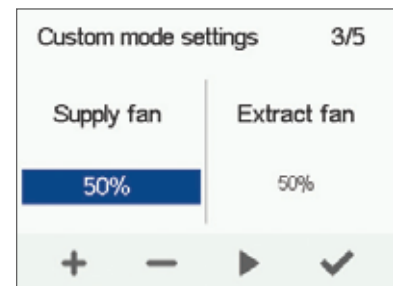
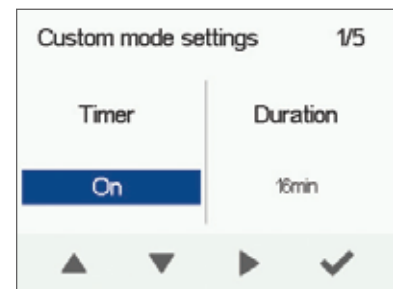

Adroit® DV245 (Integral CO₂ Sensor)

TEMPERATURES AND SENSORS

VIEWING TEMPERATURE DATA

If you want to view the system temperature and sensor data, proceed as follows:

1. Select **Settings > Temperatures and sensors**.
2. Press the **OK** button.
3. The temperature and sensors summary screen is opened.

This screen contains the following information:

- **Indoor** — Indicates the temperature of the air flowing into the unit to be removed from the property.
- **Outdoor** — Indicates the temperature of the air flowing into the unit from outdoors.
- **Supply** — Indicates the temperature of the air flowing into the property from the unit.
- **Exhaust** — Indicates the temperature of the exhaust air flowing outdoors from the unit.

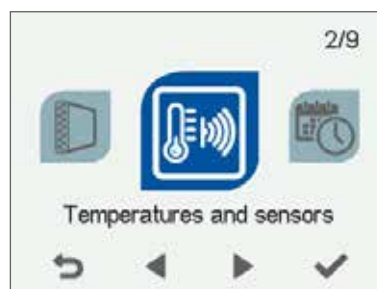

i TIP

The temperature and sensor data can also be viewed by pressing the temperature button on the profile display.

VIEWING TEMPERATURE STATISTICS

If you want to view the system temperature statistics, proceed as follows:

1. Select **Settings > Temperatures and sensors**.
2. Press the **OK** button.
3. The temperatures summary screen is opened.
4. Press the **Statistics** button.
5. A graph is opened, describing the indoor air temperature over the last 24 hours.
6. To view weekly statistics, press the **Plus** button.
7. A graph is opened, describing the indoor air temperature over the last seven days.
8. You can return to daily statistics by pressing the **Minus** button.
9. You can return to the temperature type selection by pressing the **Back** button.
10. Press the **Right arrow** button.
11. A graph is opened, describing the outdoor air temperature over the last 24 hours.
12. If you want to view weekly statistics, press the **Plus** button.
13. A graph then opens showing the outdoor air temperature over the last seven days.
14. You can return to daily statistics by pressing the **Minus** button.
15. You can return to the temperature type selection by pressing the **Back** button.
16. Press the **Right arrow** button.

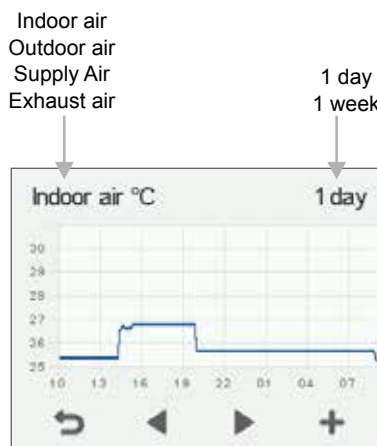

Indoor air temperature graph for the last 24 hours. The outdoor air and supply air values are presented on a similar display. You can view the graph for a week or for a single day.

Adroit® DV245

(Integral CO₂ Sensor)

TEMPERATURES AND SENSORS

1. A graph is opened, describing the supply air temperature over the last 24 hours.
2. If you want to view weekly statistics, press the **Plus** button.
3. A graph is opened, describing the supply air temperature over the last seven days.
4. You can return to daily statistics by pressing the **Minus** button.
5. You can return to the temperature type selection by pressing the **Back** button.
6. Press the **Right arrow** button.
7. A graph is opened, describing the waste air temperature over the last 24 hours.
8. If you want to view weekly statistics, press the **Plus** button.
9. A graph is opened, describing the waste air temperature over the last seven days.
10. You can return to daily statistics by pressing the **Minus** button.
11. You can return to the temperature type selection by pressing the **Back** button.
12. To exit the menu, press the **Back** button.



VIEWING HUMIDITY AND CARBON DIOXIDE VALUES

If you want to view individual humidity and carbon dioxide sensor data, proceed as follows:

1. Select **Settings > Temperatures and sensors**.
2. Press the **OK** button.
3. The temperature and sensors summary screen is opened.
4. Press the **Right arrow** button.
5. A screen displaying the maximum humidity value from the air humidity sensors is opened. The value refers to the relative humidity of the air.
6. Press the **Right arrow** button.
7. A screen displaying the maximum humidity value from the air humidity extract air sensor is opened again.
8. Press the **Right arrow** button.
9. A screen displaying the maximum carbon dioxide value from the air carbon dioxide extract air sensor is opened.
10. Press the **Right arrow** button.
11. A screen displaying the maximum carbon dioxide value from the air carbon dioxide extract air sensor is opened again.
12. To exit the menu, press the **Back** button.

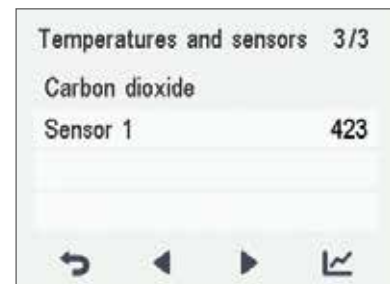
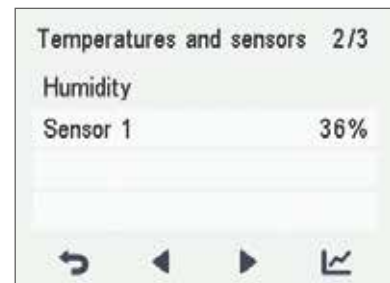

Adroit® DV245 (Integral CO₂ Sensor)

TEMPERATURES AND SENSORS

VIEWING HUMIDITY AND CARBON DIOXIDE STATISTICS

If you want to view statistics on the humidity and carbon dioxide values, proceed as follows:

1. Select **Settings > Temperatures and sensors**.
2. Press the **OK** button.
3. The temperature and supply and extract air sensors summary screen is opened.
4. Press the **Right arrow** button.
5. A screen displaying the values of the humidity extract air sensor 1-3 is opened.
6. Press the **Statistics** button.
7. A graph is opened, describing the values from the humidity sensor that gave the largest humidity value over the last 24 hours.
8. To view weekly statistics, press the **Plus** button.
9. A graph is opened, describing the values from the humidity sensor that gave the largest humidity value over the last seven days.
10. You can return to daily statistics by pressing the **Minus** button.
11. You can return to the sensor group selection by pressing the **Back** button.
12. Press the **Right arrow** button twice.
13. A screen displaying the values of the carbon dioxide extract air sensor 1-3 is opened.
14. Press the **Statistics** button.
15. A graph is opened, describing the values from the carbon dioxide sensor that gave the largest carbon dioxide value over the last 24 hours.
16. If you want to view weekly statistics, press the **Plus** button.
17. A graph is opened, describing the values from the carbon dioxide sensor that gave the largest carbon dioxide value over the last seven days.
18. A graph opens on the display showing the carbon dioxide level recorded over the last seven days by the extract air sensor with the highest values.
19. You can return to daily statistics by pressing the **Minus** button.
20. Return to the sensor group selection and exit by pressing the **Back** button twice.

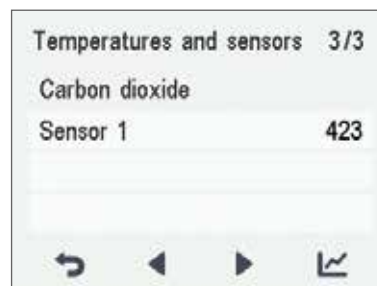
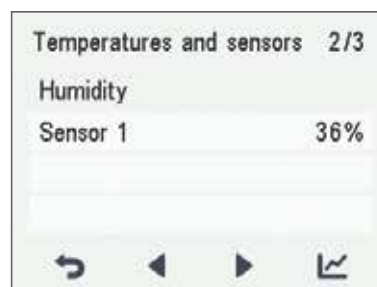

RELATIVE HUMIDITY OF AIR AND CARBON DIOXIDE LEVEL GRAPHS

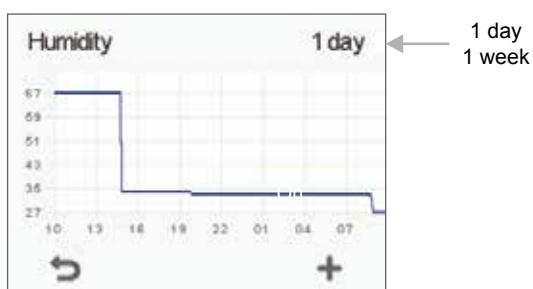

Relative humidity of air statistics for the past 24 hours. You can view the graph for a week or for a single day.

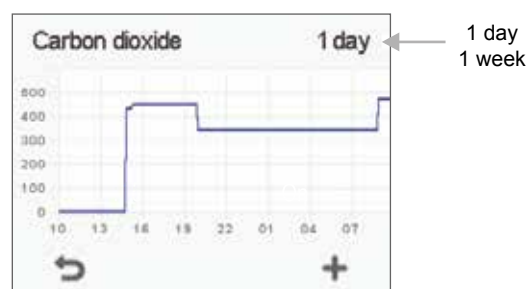

Carbon dioxide statistics for the past week. You can view the graph for a week or for a single day.

Adroit® DV245 (Integral CO₂ Sensor)

SETTINGS

FILTER SETTINGS

If you want to browse through the filter settings, proceed as follows:

1. Select **Settings > Filters**.
2. Press the **OK** button.
3. The Filters status summary screen is opened.
4. This screen contains the following information:
 - **Filters changed** — Indicates the date when the filter was last replaced.
 - **Next reminder** — Indicates the date when a reminder to replace the filter will next be shown.
 - **Reminder interval** — Indicates the filter replacement interval in months.

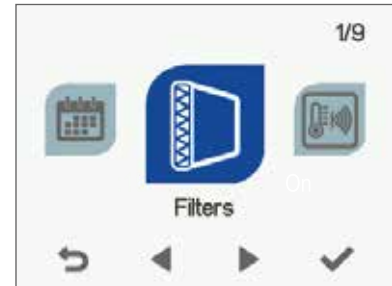

SETTING THE DATE THE FILTERS WERE LAST REPLACED

This section describes how to enter information in the controller on replacing the ventilation unit filter. Replacing the filter itself is described in the ventilation unit maintenance instructions.

If you want to set the date for replacing the ventilation unit filter, proceed as follows:

1. Select **Settings > Filters**.
2. Press the **OK** button.
3. The filter status summary screen is opened.
4. Press the **Edit** button.
5. The **Filter status** 1/2 screen is opened.
6. Press the **Plus** button. The **Filters changed** field value changes to **Today**.
7. Press the **OK** button.

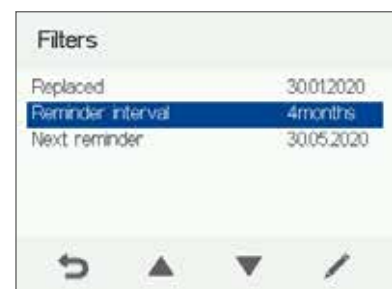
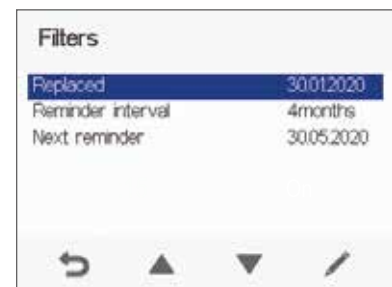

Adroit® DV245 (Integral CO₂ Sensor)

SETTINGS



NOTE

The system will automatically set the service reminder to remind you of the filter replacement. The reminder will be displayed when the set reminder interval has elapsed.

SETTING THE FILTER REPLACEMENT REMINDER INTERVAL

This section describes how to set the filter replacement reminder interval.

If you want to set the reminder interval for replacing the ventilation unit filter, proceed as follows:

1. Select **Settings > Filter**.
2. Press the **OK** button.
3. The filter status summary screen is opened.
4. Press the **Edit** button.
5. Press the **Right arrow** button.
6. The **Filter status 2/2** screen is opened.
7. Set the desired reminder interval in months in the **Reminder interval** field by using the **Plus** and **Minus** buttons. You can set the interval value from 1 to 12 months. The factory setting is 4 months.
8. Press the **OK** button.

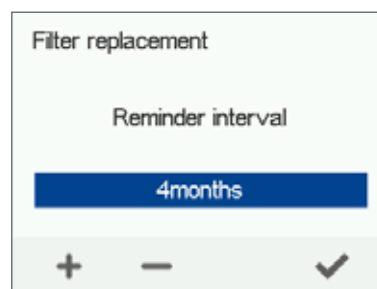
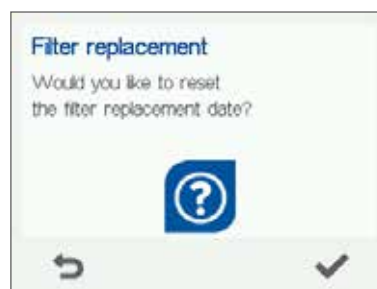

FILTER MAINTENANCE REMINDER

The maintenance reminder reminds you of the filter replacement with a pop-up window.

To acknowledge the maintenance reminder message, press the OK button.

Press the clock button to postpone the reminder for one week.



Adroit® DV245 (Integral CO₂ Sensor)

SETTINGS

DISPLAY SETTINGS

SETTING THE SLEEP TIME

The controller automatically switches to sleep mode when the pre-set sleep time has elapsed. To set the sleep time, proceed as follows:

1. Select **Settings > Display settings**.
2. Press the **OK** button.
3. The Display settings 1/2 appears.
4. Use the **Plus** and **Minus** buttons to set the sleep time.
5. Press the **OK** button.

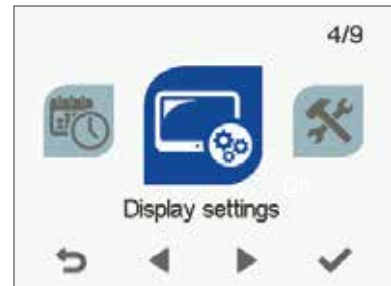

i TIP

The Adroit Digital Controller automatically switches to sleep mode when the pre-set sleep time has elapsed. To reactivate the Adroit Digital Controller, press any button.

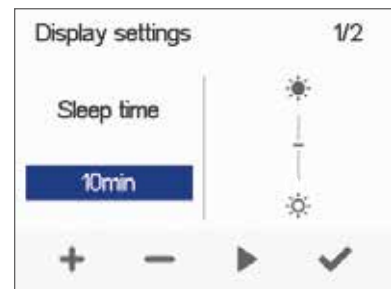

ADJUSTING THE DISPLAY BRIGHTNESS

To set the display brightness, proceed as follows:

1. Select **Settings > Display settings**.
2. Press the **OK** button.
3. The Display settings screen appears.
4. Press the **Right arrow** button.
5. **The Display settings 2/2** screen appears.
6. Use the **Plus** and **Minus** buttons to set the display brightness.
7. Press the **OK** button.



SELECTING THE USER INTERFACE LANGUAGE

You can select the user interface language as follows:

1. Select **Settings > Language**.
2. Press the **OK** button.
3. Select the language you want, for example, English.
4. Press the **OK** button.

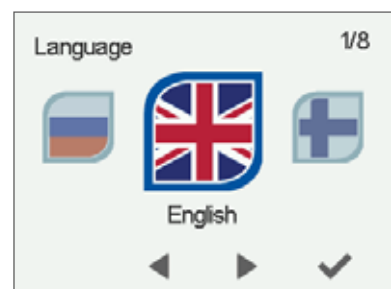

Adroit® DV245 (Integral CO₂ Sensor)

SETTINGS

TIME AND DATE

SETTING THE TIME AND DATE

The following sections explain how to set:

- Time
- 24- or 12-hour clock
- Automatic daylight-saving time
- Date



NOTE

The system time will stay active for a few hours if the power is cut to the unit.

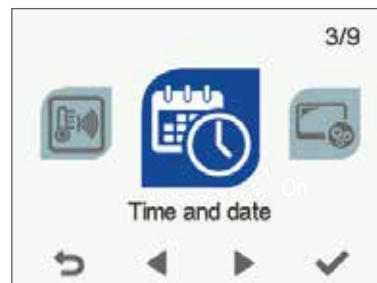

SETTING THE TIME

To set the time, proceed as follows:

1. Select **Settings > Time and date**.
2. Press the **OK** button.
3. The **Time and date** settings are opened.
4. Use the **Plus** and **Minus** buttons to set the hours.
5. Press the **Right arrow** button.
6. Use the **Plus** and **Minus** buttons to set the minutes.
7. Press the **OK** button.

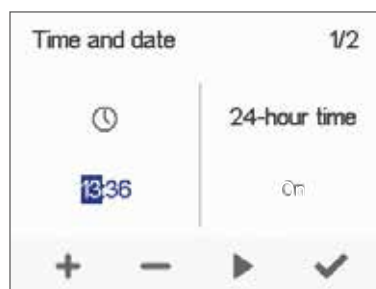

SELECTING THE 24- OR 12-HOUR CLOCK

By default, the system uses a 24 hour clock. If you want to use the 12 hour clock, proceed as follows:

1. Select **Settings > Time and date**.
2. Press the **OK** button.
3. The **Time and date** settings are opened.
4. Press the **Right arrow** until the display 2/4 opens.
5. Press the **Minus** button. The **24-Hour Time** setting value is changed to **Off**.
6. Press the **OK** button.

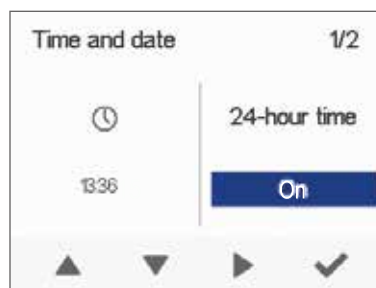

SETTING THE AUTOMATIC DAYLIGHT SAVING TIME

If you want the system to automatically switch over to daylight saving time, proceed as follows:

1. Select **Settings > Time and date**.
2. Press the **OK** button.
3. The **Time and date** settings open.
4. Press the **Right arrow** until the display 3/4 opens.
5. Press the **Plus** button. The **Daylight saving time** setting value is changed to **On**.
6. Press the **OK** button.

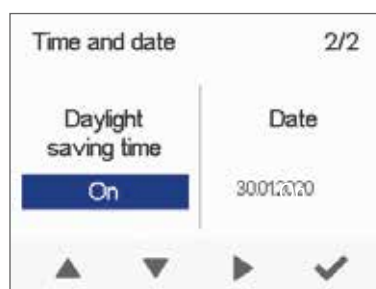

Adroit® DV245 (Integral CO₂ Sensor)

SETTINGS

TIME AND DATE

SETTING THE DATE

To set the date, proceed as follows:

1. Select **Settings > Time and date**.
2. Press the **OK** button.
3. The **Time** and **date** settings are opened.
4. Press the **Right arrow** until the display 4/4 appears.
5. Use the **Plus** and **Minus** buttons to set the date.
6. Press the **Right arrow** button.
7. Use the **Plus** and **Minus** buttons to set the month.
8. Press the **Right arrow** button.
9. Use the **Plus** and **Minus** buttons to set the year.
10. Press the **OK** button.

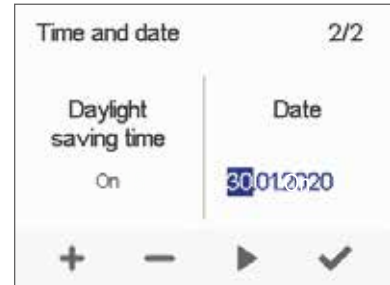

WEEK CLOCK

The Week clock allows you to program a weekly program for the ventilation unit. The program controls the unit by changing the ventilation profile. You can set one of the following conditions for each hour of the week:

- **At Home** — Use the **At home** profile.
- **Away** — Use the **Away** profile.
- **Boost** — Use the **Boost** profile.
- **Custom** — Use the **Custom** profile.
- **Standby** — The ventilation unit has been turned off.
- **Empty** — The previous mode is used.

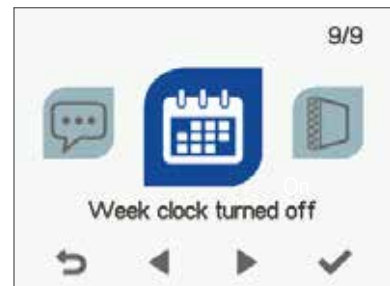

NOTE

If you change the profile manually when the Week clock is on, the selected profile will be active until the Week clock switches to the next profile in the program.

If the humidity or carbon dioxide sensors control the ventilation, they will adjust the fan speed regardless of whether the profile has been manually selected or selected by the Week clock.

ENABLING THE WEEK CLOCK ON

To turn the Week clock on, proceed as follows:

1. Select **Settings > Week clock**.
2. Press the **OK** button.
3. The week view in the Week clock is displayed.
4. Press the **Settings** button.
5. **The Week clock menu** appears.
6. Select **Turn on**.
7. Press the **Select** button.
8. A confirmation screen is opened.

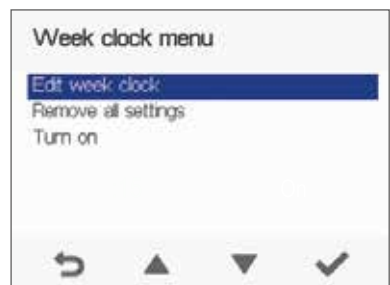

TIP

You can switch the Week clock **ON** or **OFF** by pressing the **OK** button in the **Week clock** screen for a few seconds.





Adroit® DV245 (Integral CO₂ Sensor)

SETTINGS

WEEK CLOCK

SETTING AND EDITING THE WEEKLY PROGRAM

If you want to set the weekly timer program or edit an existing program, proceed as follows:

1. Select **Settings > Week clock**.
2. Press the **OK** button.
3. The week view in the Week clock is displayed.
4. Use the **Right arrow** button to select the desired day.
5. Use the **Down arrow** button to select the desired time.
6. Use the **Select** button to browse and select the ventilation profile that will be turned on at the chosen time. Use the **Select** button to browse the profile icons. The icons are:
 -  • This icon selects the **At home** profile.
 -  • This icon selects the **Away** profile.
 -  • This icon selects the **Boost** profile.
 -  • This icon selects the **Custom** profile.
 -  • This icon selects the **Standby** profile.
7. Set the other profile changes for the Week clock as described above.
8. Press the **Settings** button.
9. The **Week clock menu** opens.
10. Select **Save and Quit**.
11. To exit without saving the weekly program or changes, select **Cancel and Quit**.
12. A confirmation display opens.
13. Press the **OK** button.

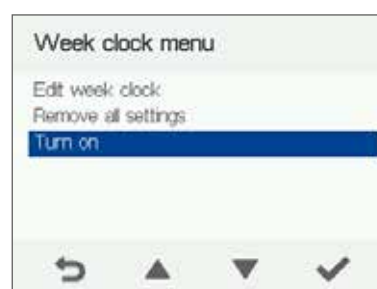
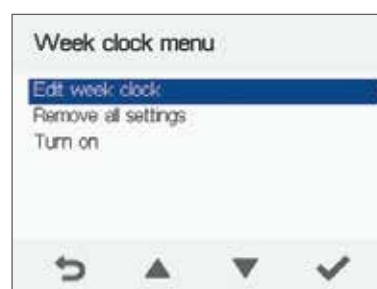
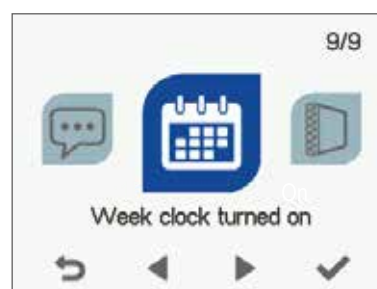

TURNING THE WEEK CLOCK OFF

If you want to disable the Week clock, proceed as follows:

1. Select **Settings > Week clock**.
2. Press the **OK** button.
3. Press the **Settings** button.
4. **The Week clock menu** opens.
5. Select **Turn Off**.
6. Press the **Select** button.
7. A confirmation screen is opened.
8. The Week clock is now disabled. If you have set a weekly program, it will be saved in the system.

Adroit® DV245 (Integral CO₂ Sensor)

SETTINGS

REMOVING THE WEEKLY PROGRAM

If you want to remove the weekly program settings from the system, proceed as follows:

1. Select **Settings > Week clock**.
2. Press the **OK** button.
3. Press the **Settings** button.
4. The **Week clock menu** opens.
5. Select **Remove all settings**.
6. The confirmation screen for removing the weekly program is opened.
7. Press the **OK** button.
8. A confirmation screen is opened.
9. The Week clock program has now been deleted from the system.

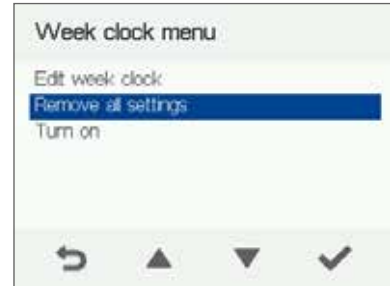

EXAMPLE OF SETTING A WEEKLY PROGRAM

In this example, the following weekly program has been set:

- Mon-Fri 08.00 - 17.00, **Away** from home.
- Mon-Fri 17.00 - 08.00, **At home**.
- Sat 08.00 - 18.00, **At home**.
- Sat 18.00 - 21.00, **Boost** that might be needed for cooking.
- Sat 21.00 - Mon 08.00, **At home**

To set the Week clock, proceed as follows:

1. Open the Week clock.
2. Select Monday and make the following settings:
 - At 8.00, select the **Away** profile.
 - At 17.00, select the **At home** profile.
3. Also make the corresponding settings for other weekdays.
4. Select Saturday and make the following settings:
 - At 18.00, select the **Boost** profile.
 - At 21.00, select the **At home** profile.
5. Ensure that the Week clock is enabled.
6. The weekly program is now set



The figures above depict a Week clock set in line with this example.

Adroit[®] DV245 (Integral CO₂ Sensor)

SETTINGS

PARTIAL BY-PASS

To turn the partial by-pass on:

1. Select **Expert** settings.
2. Find **HR cell bypass** settings.
3. Select **On** from the pop down list menu of the Partial bypass option.
4. The partial bypass has now been turned on and will run automatically based on temperature sensors inputs.
5. The partial bypass can also be used in Special modes option, which means that the partial bypass can be active during winter as well, only for special cases, e.g. used in a server room that generates heat.



NOTE

The purpose of the partial bypass option is to provide a supply air temperature as accurate as possible. This automatic partial bypass will function based on the outdoor and extract air temperatures. For instance, during the spring and autumn a high amount of heat gain is coming from the sun, but the outdoor air can still have a fairly low temperature. So, if the supply air goes through the heat exchanger, the supply air temperature can be too high. Same for the case where the supply air is bypassed and no heat is being recovered, the supply air temperature can be too cold.

However, if the supply air temperature is set e.g. at 16° Celsius, the bypass damper will move into a suitable position where enough outdoor air is mixed with the supply air the outcome is providing a more accurate supply air temperature of 16° Celsius.

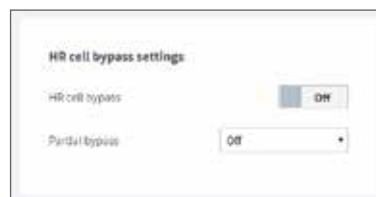

SWITCHING THE UNIT OFF

To turn the ventilation unit off:

1. Select **Settings> Turn unit off**.
2. Press the **OK** button.
3. The system asks for confirmation.
4. Press the **OK** button.
5. The ventilation unit has now been turned off



TIP

To re-start the ventilation unit, press any key. We advise against switching off the unit as the chosen ventilation system is continuous.

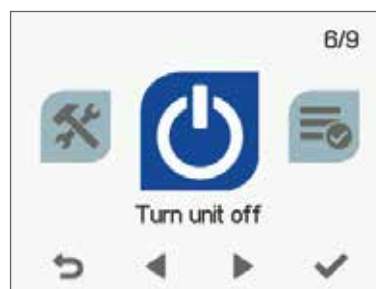

Adroit® DV245 (Integral CO₂ Sensor)

MAINTENANCE

BEFORE BEGINNING MAINTENANCE WORK

The safety switch automatically turns off the power when the upper door of the unit is opened. Always disconnect the power before starting the ventilation unit maintenance.

OPENING AND CLOSING THE DOORS

1. Turn the latches to open the upper door of the ventilation unit.
2. Lift off the door.



NOTE

Caution: The door is heavy.

3. Open the lower door of the ventilation unit by undoing the finger screws.
4. Lift the lower door off.
5. Close the doors in reverse order.

There are two unit models, left- (L) and right-handed (R). The figure shows the right-handed model.

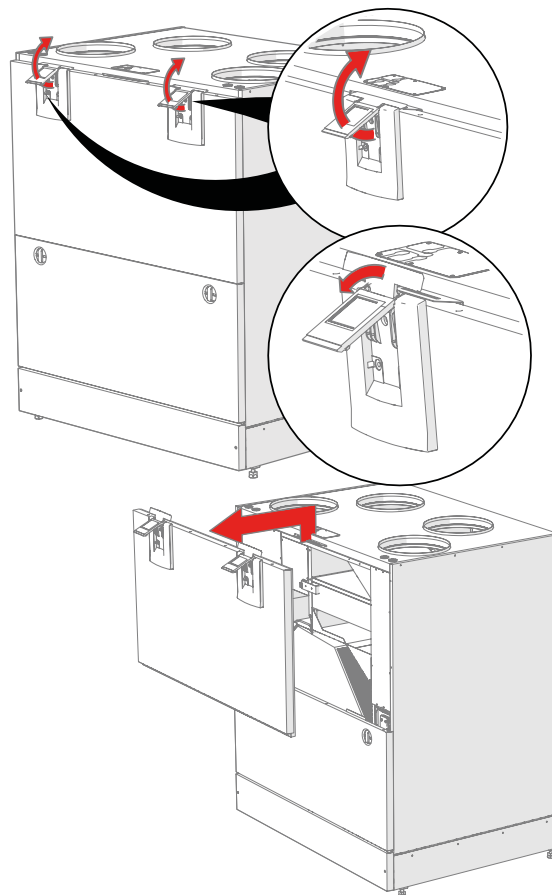

FILTERS

When the maintenance reminder becomes activated, check the cleanliness of the filters and replace them if required.

The Adroit ventilation unit has three air filters:

- Class G4 coarse filter filters insects, heavy pollen and other relatively large foreign objects out of the outdoor air.
- Class F7 fine filter filters microscopic pollen and dust particles out of the supply air.
- The coarse filter filters the extract air and keeps the heat recovery cell clean.

The filter change interval depends on the ambient dust concentration. It is recommended that the filters are changed every spring and autumn or at the very least once a year.



TIP

Using original Airflow filters ensures that the ventilation unit remains in top condition, giving the best results.

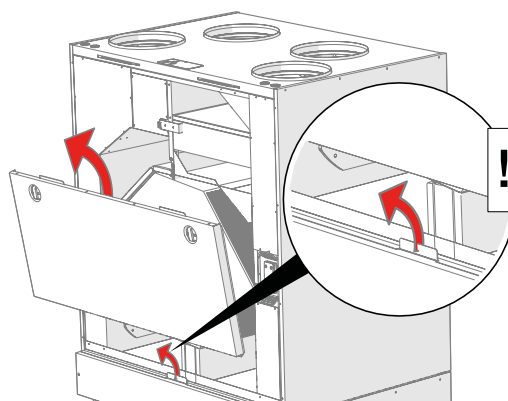

Adroit® DV245 (Integral CO₂ Sensor)

MAINTENANCE

To change the filters:

1. Disconnect the ventilation unit from the mains electricity supply.
2. Open the upper door of the unit.
3. Remove the old filters (A, B, C) and discard them.
4. Install the new filters (A, B, C).
5. Close the door of the unit. Ensure that the safety switch of the door is engaged, allowing the unit to be turned on.
6. Connect the ventilation unit back into the mains.
7. The filters have now been successfully changed.

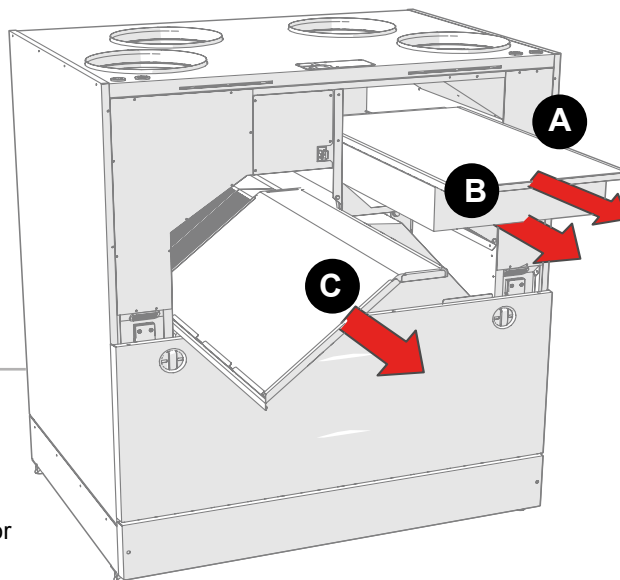

HEAT RECOVERY CELLS

Check that the heat recovery cells are clean every two years or whenever the filters are being changed.



NOTE

If the unit has an enthalpy cell, it must not be washed. Only aluminium or plastic cells can be washed.

To check and clean the heat recovery cell:

1. Disconnect the ventilation unit from the mains electricity supply.
2. Open the doors of the unit.
3. Remove the filters (A, B, C).
4. Remove the support grid of the filters.
5. Disengage the upper support strip (D) of the heat recovery cell.
6. Lift and pull the cell (E) out of the unit.
7. If the heat recovery cell is dirty, clean it by immersing it in warm water, to which a small amount of a mild detergent has been added.
8. Rinse the heat recovery cell. clean with water spray. Do not use a high-pressure cleaner.
9. When all the water has drained from between the plates, reassemble the ventilation unit in the reverse order.
10. Close the doors and connect the unit back into the mains.
11. The heat recovery cell has now been checked and cleaned.

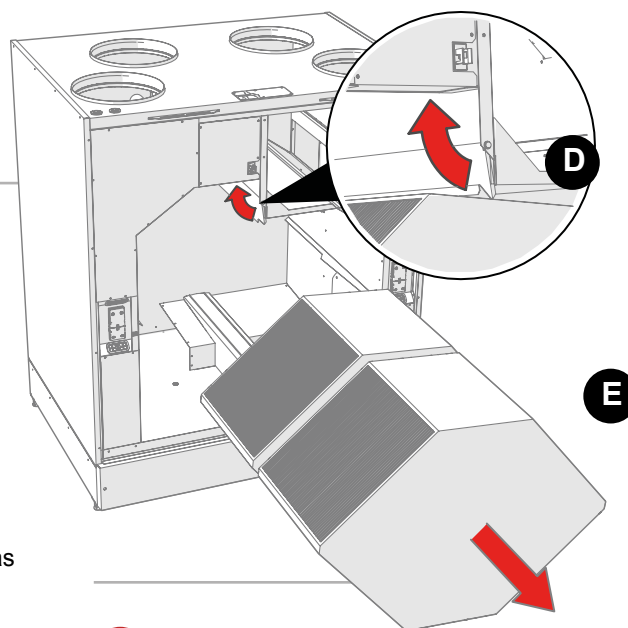

WARNING

Handle the heat recovery cell carefully! Do not lift the cells by the plates, as they can be easily damaged.

Adroit® DV245 (Integral CO₂ Sensor)

MAINTENANCE

FANS

Check the cleanliness of the fans when servicing the filters and the heat recovery cell. Clean the fans as required.

You can clean the fan blades with compressed air or by brushing them gently.

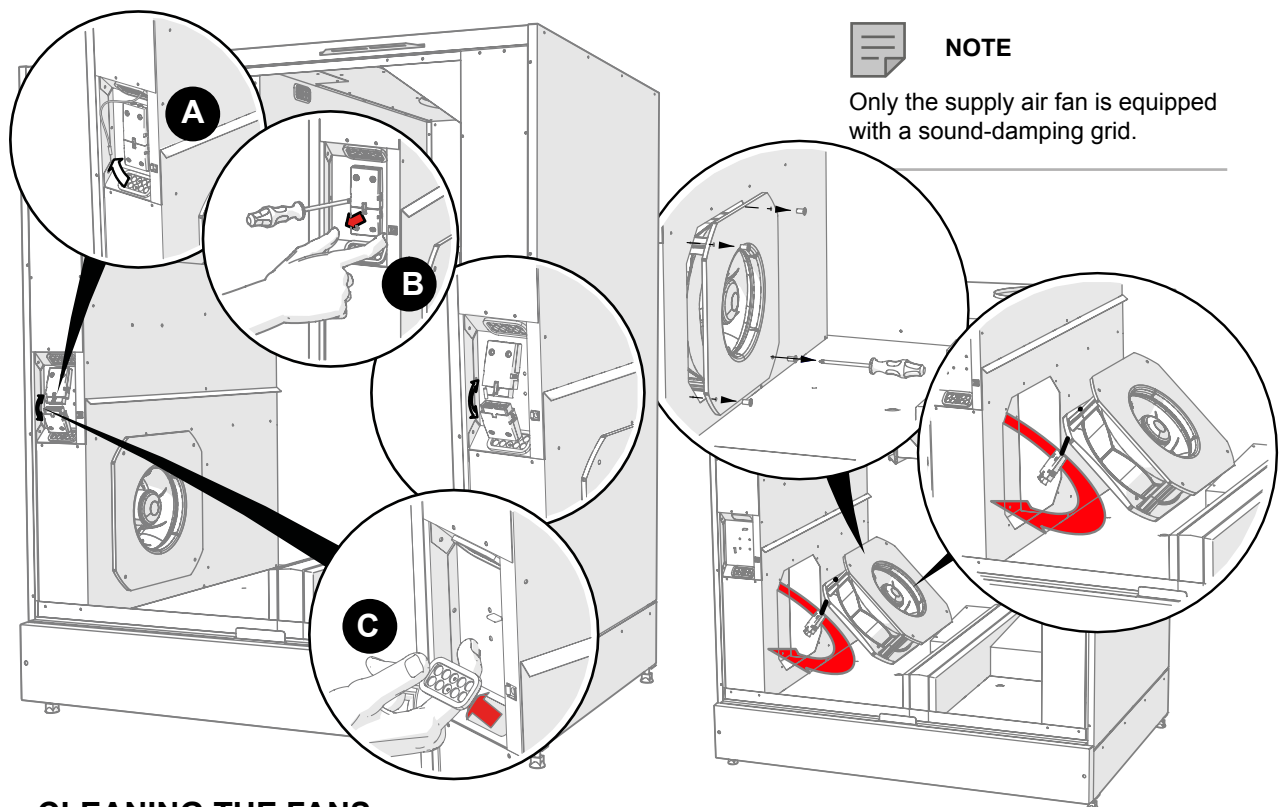

CLEANING THE FANS

To clean the supply air fan:

1. Disconnect the ventilation unit from the mains electricity supply.
2. Open the doors of the unit.
3. Pull the temperature sensor out of the rubber feed through (A).
4. Disconnect the quick connector (B) of the fan cables.
5. Remove the rubber feed through (C).
6. Undo the fan's mounting screws.
7. Pull the fan out of its housing.
8. Clean the fan.
9. To reassemble the ventilation unit, follow the above steps in reverse order.
10. Close the doors and connect the unit back into the mains.
11. The fan has now been checked and cleaned.

Clean the extract air fan in the same way. The extract air fan is located symmetrically on the opposite side of the unit.

! WARNING

The fans are extremely sensitive to external shocks and to minimize risk of damage, we recommend that the fans be cleaned in place, i.e. without attempting to remove them.

! WARNING

Remember to replace the temperature sensor by feeding it through the rubber feed.

Adroit® DV245 (Integral CO₂ Sensor)

MAINTENANCE

REMOVING THE ELECTRIC HEATER

To remove the heater:

1. Disconnect the ventilation unit from the mains electricity supply.
2. Open the doors of the unit.
3. Open the heater box by undoing the mounting screws (10 PZ2 screws).
4. Remove the quick connector of the heater:
 - a. Press down the locking device.
 - b. Pull off the connector.
5. Undo the two wing nuts connecting the heater to the ventilation unit.
6. Lift the heater out of the ventilation unit.
7. To reassemble the ventilation unit, follow the above steps in reverse order.

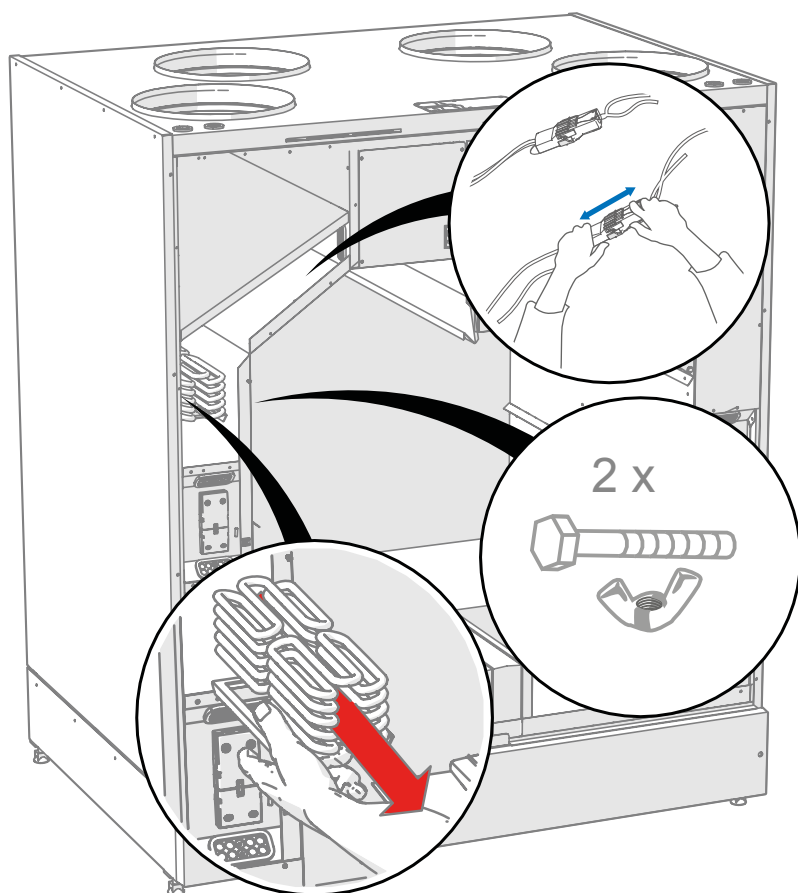
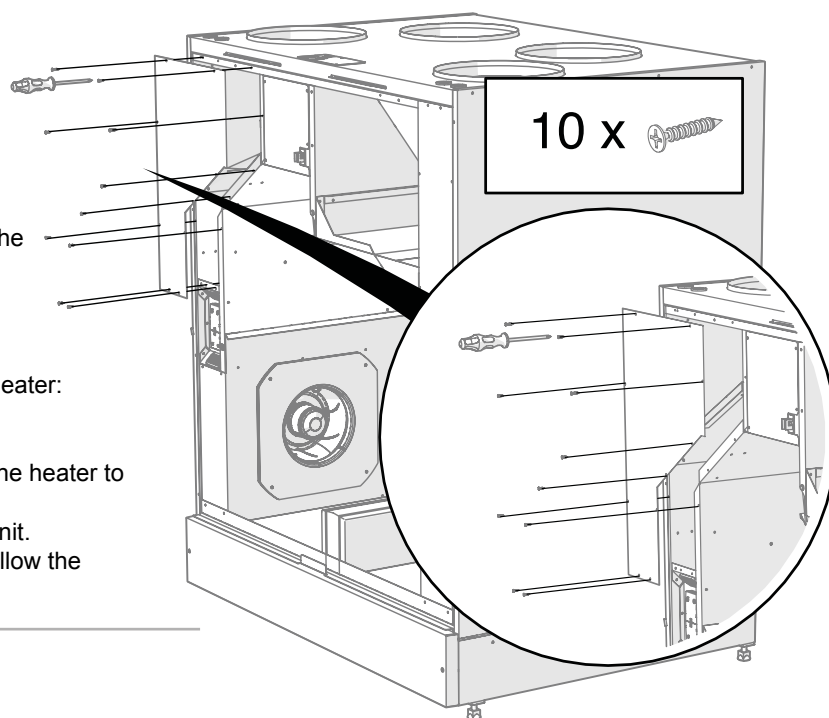

! WARNING

Connect the cables so that they do not touch the heater.

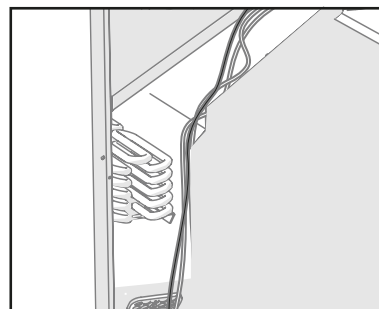

! WARNING

Before removing the heater from the unit, make sure it is not hot.

Adroit[®] DV245 (Integral CO₂ Sensor)

MAINTENANCE

TROUBLESHOOTING



NOTE

Error messages are displayed on the controller and in the Adroit Home and Adroit Cloud services.

FAULT	CAUSE	MEASURES
Message on the user interface: Extract fan stopped	The extract air fan has stopped.	Make sure that the fan is not running. The fan cabling and operation must be checked and if necessary, the fan must be replaced. Contact the service centre.
Message on the user interface: Supply fan stopped	The supply air fan has stopped.	Make sure that the fan is not running. The fan cabling and operation must be checked and if necessary, the fan must be replaced. Contact the service centre.
Message on the user interface: Heat recovery cell has frozen	The heat recovery cell has become excessively cold.	Conduct a manual defrost through the controller (Service menu > Cell defrost). Try to discover why the heat recovery cell is frozen.
Message on the user interface: Temperature sensor 1/2/3/4/5	The temperature sensor indicated on the user interface is damaged.	The sensor installation must be checked and if required, the sensor must be replaced. Contact the service centre.
Message on the user interface: External sensor	The external temperature sensor is damaged.	The sensor installation must be checked and if required, the sensor must be replaced. Contact the service centre.
Message on the user interface: Post-heater	The post-heater does not heat.	The heater installation must be checked and if required, the heater must be replaced. Contact the service centre.
Message on the user interface: Bus fault	Problems with the data transfer bus.	Make sure that the Modbus bus is connected correctly and that the devices connected to it are properly functioning.
The ventilation unit is not working; the controller is not working.	Power input to the unit is lost.	Check: • Fuse in the fusebox • Fuse in the unit
The ventilation unit is working, but the controller is not working.	Either the controller 24 VDC power is lost, or the controller is damaged.	Check the cables from the unit to the controller. Contact the service centre if necessary.

CONDENSING WATER

MAINTENANCE OF THE CONDENSING WATER OUTLETS

In the heating season, the extract air humidity condenses into water. In new buildings, condensation runoff can form rapidly. Condensed water must be able to freely leave the unit. At some time before the heating season begins (e.g. during autumn maintenance), check that the condensing water outlets in the bottom pool are not clogged and that there are no leakages. To check this, pour some water into the pool. Clean as required. Check where the condensing water outlets are in the Installation section.



NOTE

Some condensing water may have accumulated in the bottom pool of the unit; this is normal and requires no corrective action.



WARNING

Water must be kept out of the electrical system at all times..

Adroit® DV245 (Integral CO₂ Sensor)

INSTALLATION

INSTALLING THE CONDENSING WATER OUTLETS

1. Open the doors of the unit.
2. Remove the front panel of the base by undoing the two hexagon screws.
3. Remove the body of the condensing water outlet (A) from the housing (B) and remove the tension pin (C).
4. Push the main body of the condensing water outlet downward from above, through the hole in the bottom plate of the ventilation unit.
5. Push the tension pin downward from below towards the main body.
6. Place the valve ball inside the housing of the condensing water outlet.
7. Attach the housing to the condensing water outlet.
8. Install the second outlet in the same way.
9. To reassemble the ventilation unit, follow the above steps in reverse order.



WARNING

Water must not be allowed to enter the electrical system.

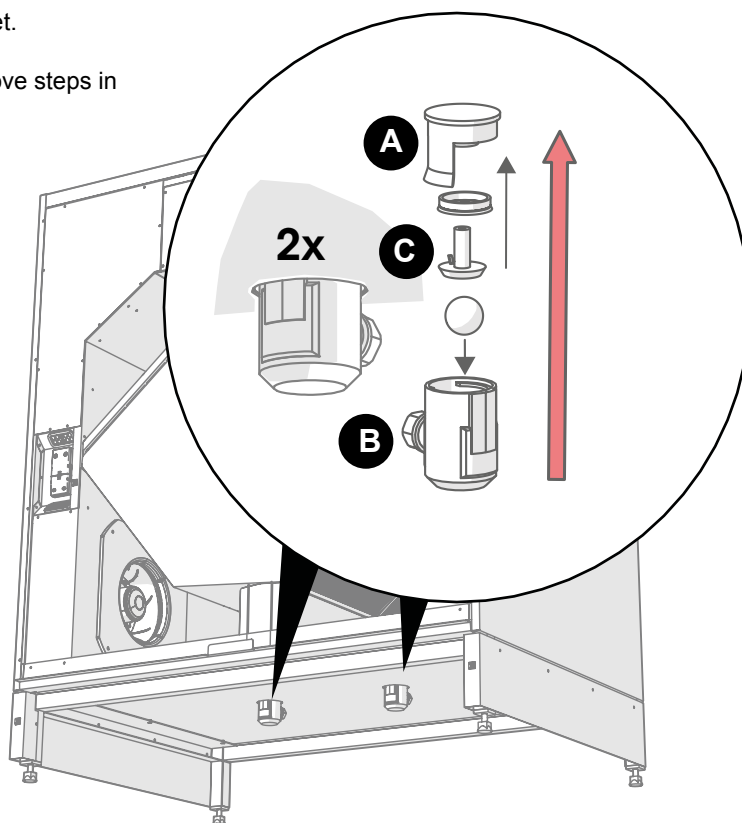
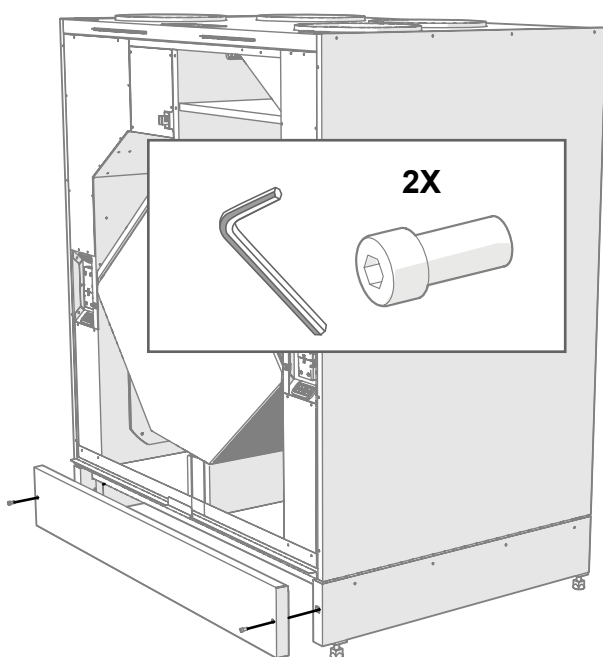

MEASURING TUBES

The accessories delivered with the unit include four airflow measuring tubes. These can be inserted in the ducts to allow for easier ventilation adjustment.

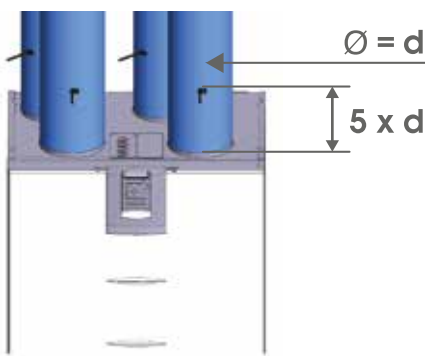
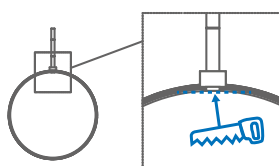
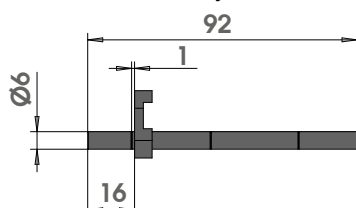

Adroit® DV245 (Integral CO₂ Sensor)

TECHNICAL SPECIFICATIONS DV245 ADROIT

TECHNICAL SPECIFICATIONS

Product codes DV245 (R) Adroit (Integral CO ₂ Sensor) DV245 (L) Adroit (Integral CO ₂ Sensor)*	Product number 90001271, 90001271EPH 90001272, 90001272EPH	Fans Supply air Extract air	0.170 kW 1.25A EC 0.170 kW 1.25A EC
Air volumes Supply air Extract air	247 l/s, 100 Pa 271 l/s, 100 Pa	Filters Supply air Extract air	ISO Coarse > 75% (G4) and ISO ePM1 (F7) ISO Coarse > 75% (G4) - ISO 16890 compliant
Enclosure protection class	IP 34	Heat recovery bypass	Automatic
Optional post-heater	Power, 900W	Operating efficiencies Annual efficiency Supply air efficiency Specific Fan Power (SFP)	83% 85% 0.68W(l/s)
Electrical connection	230V, 50Hz, 14.5 A	Weight	181 kg
Dimensions (w x h x d)	1038 x 1241 x 773 mm		

FAN INPUT POWER SUPPLY / EXTRACT AIR VOLUMES

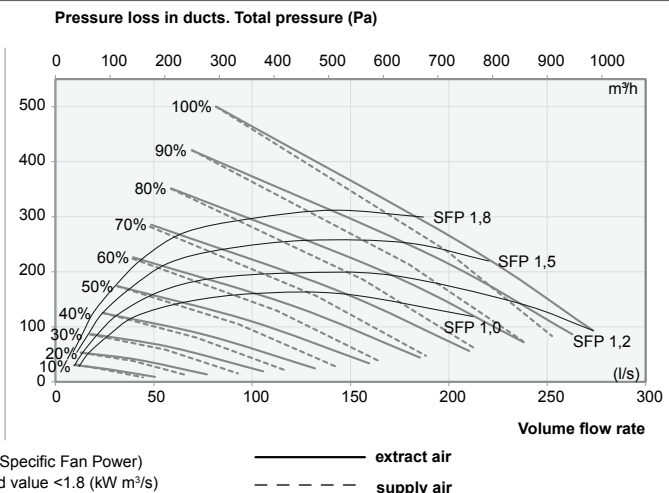
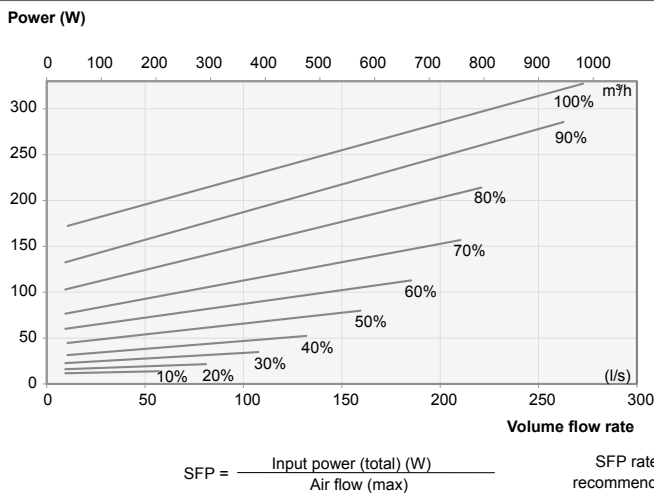

SOUND VALUES

Adjustment position (%)	Sound power level in the supply air duct (one duct) by octave band Lw, dB										Sound power level in the extract air duct (one duct) by octave band Lw, dB									
	Adjustable position																			
	10	20	30	40	50	60	70	80	90	100	10	20	30	40	50	60	70	80	90	100
63	57	66	66	69	73	75	77	79	80	82	50	51	55	59	64	65	68	72	76	76
125	43	52	57	64	66	69	71	72	73	73	38	48	50	53	54	55	57	57	59	59
250	41	46	50	55	59	64	74	72	73	75	33	39	45	48	52	60	63	63	64	64
500	35	41	48	52	55	58	61	64	67	68	24	30	36	39	42	46	49	50	52	53
1000	30	38	43	48	52	55	58	61	64	65	18	26	31	36	39	43	45	48	50	51
2000	24	33	41	46	50	54	56	59	61	63	13	18	25	30	35	38	41	44	46	47
4000	17	20	27	34	40	45	49	52	55	57	17	17	18	20	24	29	32	35	38	39
8000	21	21	22	25	31	37	42	46	49	52	21	21	21	21	21	22	23	25	28	30
LW, dB	58	66	66	70	74	77	80	80	82	84	50	56	56	61	65	67	70	73	77	77
LWA, dB(A)	38	45	50	55	59	62	68	68	70	72	30	40	40	44	48	53	56	57	59	59
Sound pressure level coming through the envelope of the unit in the room in which it is installed (10m² sound absorption)																				
Adjustable position																				
Adjustment position (%)	10	20	30	40	50	60	70	80	90	100	10	20	30	40	50	60	70	80	90	100
LpA, dB (A)	24	26	29	34	39	41	44	47	49	49	24	26	29	34	39	41	44	47	49	49

Adroit® DV245 (Integral CO₂ Sensor)

TECHNICAL SPECIFICATIONS DV245 ADROIT

MAIN PARTS

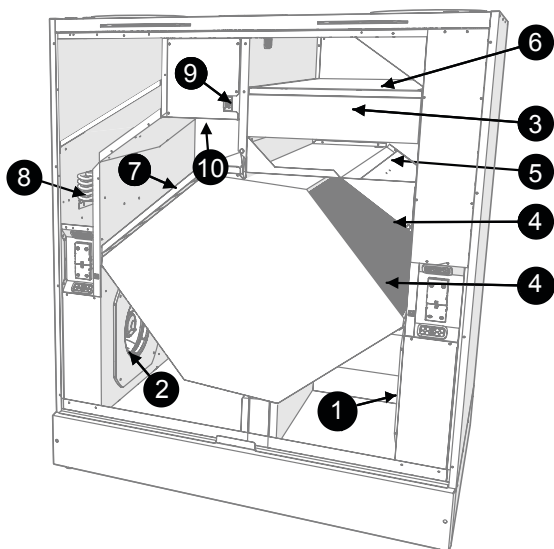

Model R in the figure.
In the L model, the parts are mirrored

- | | |
|------------------------------------|---|
| 1 Extract air fan | 5 Summer/winter damper |
| 2 Supply air fan | 6 Outdoor air filter ISO Coarse > 75% (G4) |
| 3 Outdoor air filter ISO ePM, (F7) | 7 Extract air filter ISO Coarse > 75% (G4) |
| 4 Heat recovery cell | 8 Optional Post-heating radiator |
| | 9 Safety switch |
| | 10 Internal humidity sensor (behind the electric box) |

MEASUREMENT POINTS

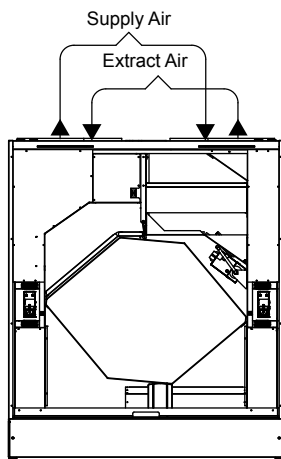

Measurement points after the connection outlet. The fan curves indicate the total pressure accounted for by duct losses.

DIMENSIONS AND DUCT OUTLETS

Dimensions

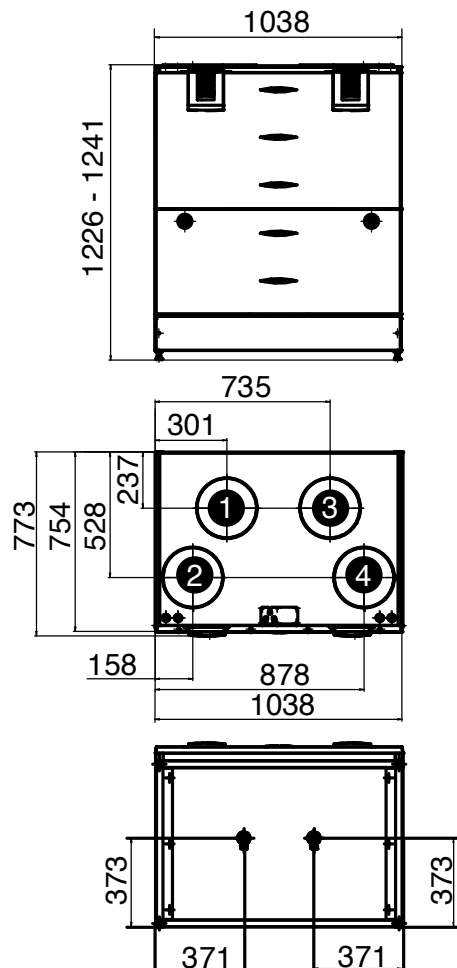

DUCT OUTLETS

Model R

Inner diameter of the female collar: 250mm

1. Extract air from the apartment to the unit
2. Supply air from the unit to the apartment
3. Outdoor air to the unit
4. Exhaust air flowing outdoors from the unit

Model L

Inner diameter of the female collar: 250mm

1. Outdoor air to the unit
2. Exhaust air flowing outdoors from the unit
3. Extract air from the apartment to the unit
4. Supply air from the unit to the apartment

Adroit® DV245 (Integral CO₂ Sensor)

EXTERNAL ELECTRICAL CONNECTION

CABLE COLOURS

BK	Black
BU	Blue
BN	Brown
WT	White
GY	Grey
YE	Yellow
YEGN	Yellow-green

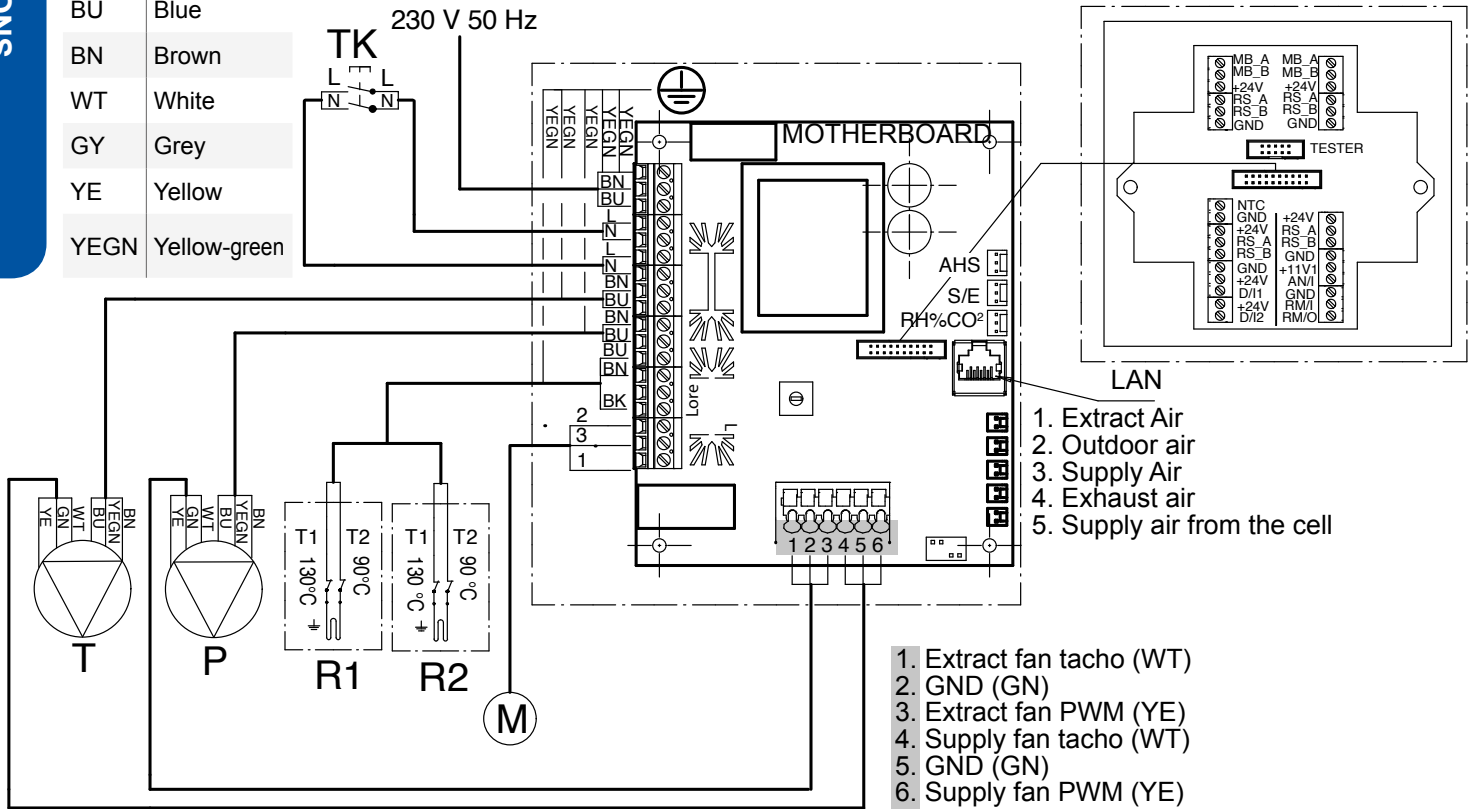

MB_A	External Modbus A signal
MB_B	External Modbus B signal
+24V	+24V direct current voltage (DC)
GND	Digital and analog ground potential
RS_A	Local hardware Modbus A signal
RS_B	Local hardware Modbus B signal
NTC	External temperature sensor connector
D/I1	Digital input 1
D/I2	Digital input 2
11V1	11.1V volt operating voltage
AN/I	AN/I = Analog input 0-10VDC
RM/I	24V relay input
RM/O	24V relay output

T	Supply air fan
P	Extract air fan
M	Damper actuator CM230-R
TK	Safety switch
AHS	Post-heating control
S/E	Fan balance adjustment
RH%CO₂	Internal humidity and carbon dioxide sensor
R1	Post-heating radiator with 90°C and 130°C overheating protection
R2	Additional heating radiator with 90°C and 130°C overheating protection

Adroit® DV245 (Integral CO₂ Sensor)

EXTERNAL ELECTRICAL CONNECTION

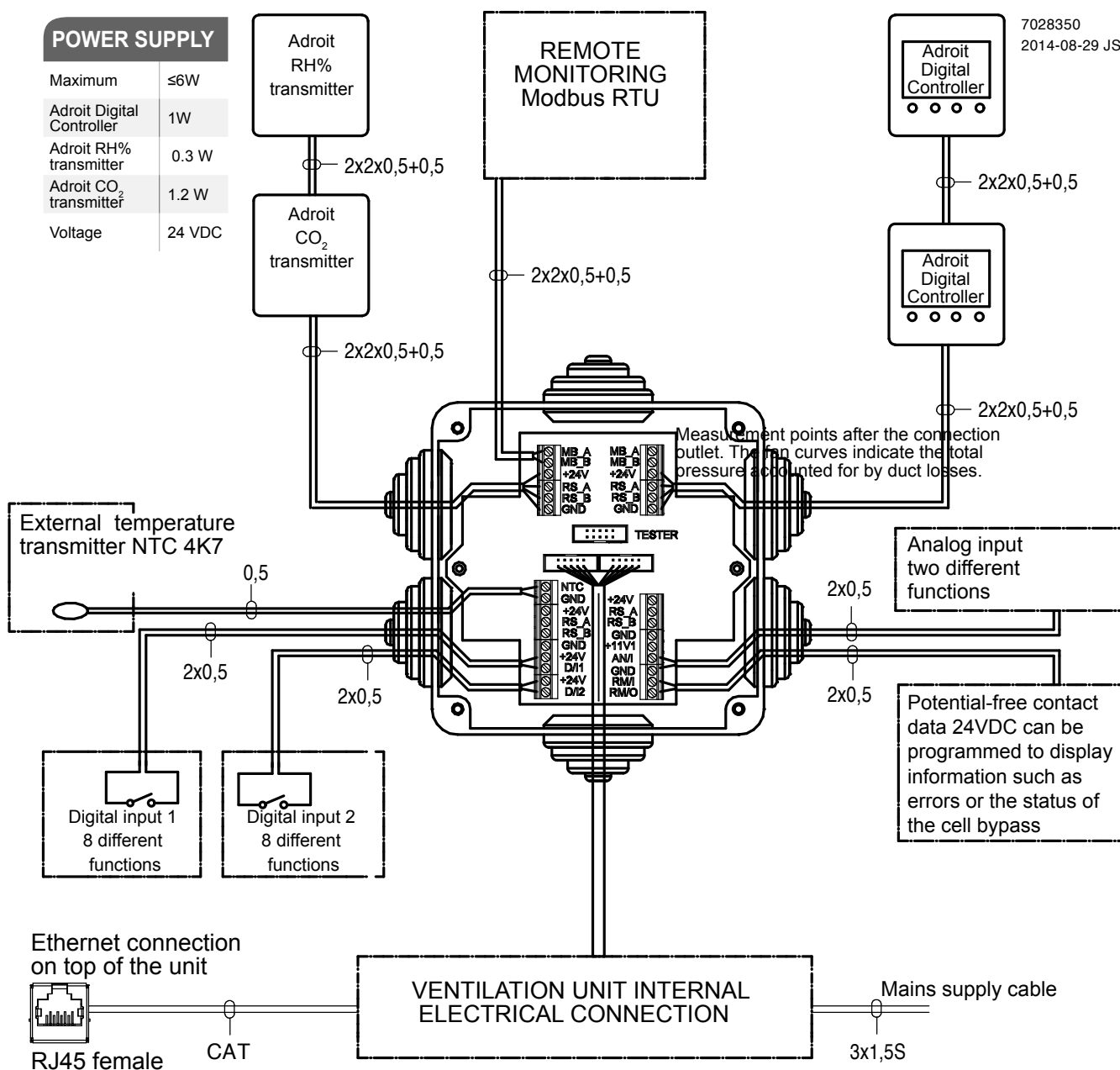

MB_A	External Modbus A signal	D/I1	Digital input 1
MB_B	External Modbus B signal	D/I2	Digital input 2
+24V	+24V direct current voltage (DC)	11V1	11.1 V operating voltage
GND	Digital and analog ground potential	AN/I	AN/I = Analog input 0-10VDC
RS_A	Local hardware Modbus A signal	RM/I	24V relay input
RS_B	Local hardware Modbus B signal	RM/O	24V relay output
NTC	External temperature sensor connector		

Adroit® DV245 (Integral CO₂ Sensor)

EXTERNAL ELECTRICAL CONNECTION FOR CONTROLLING THE DUCT RADIATOR

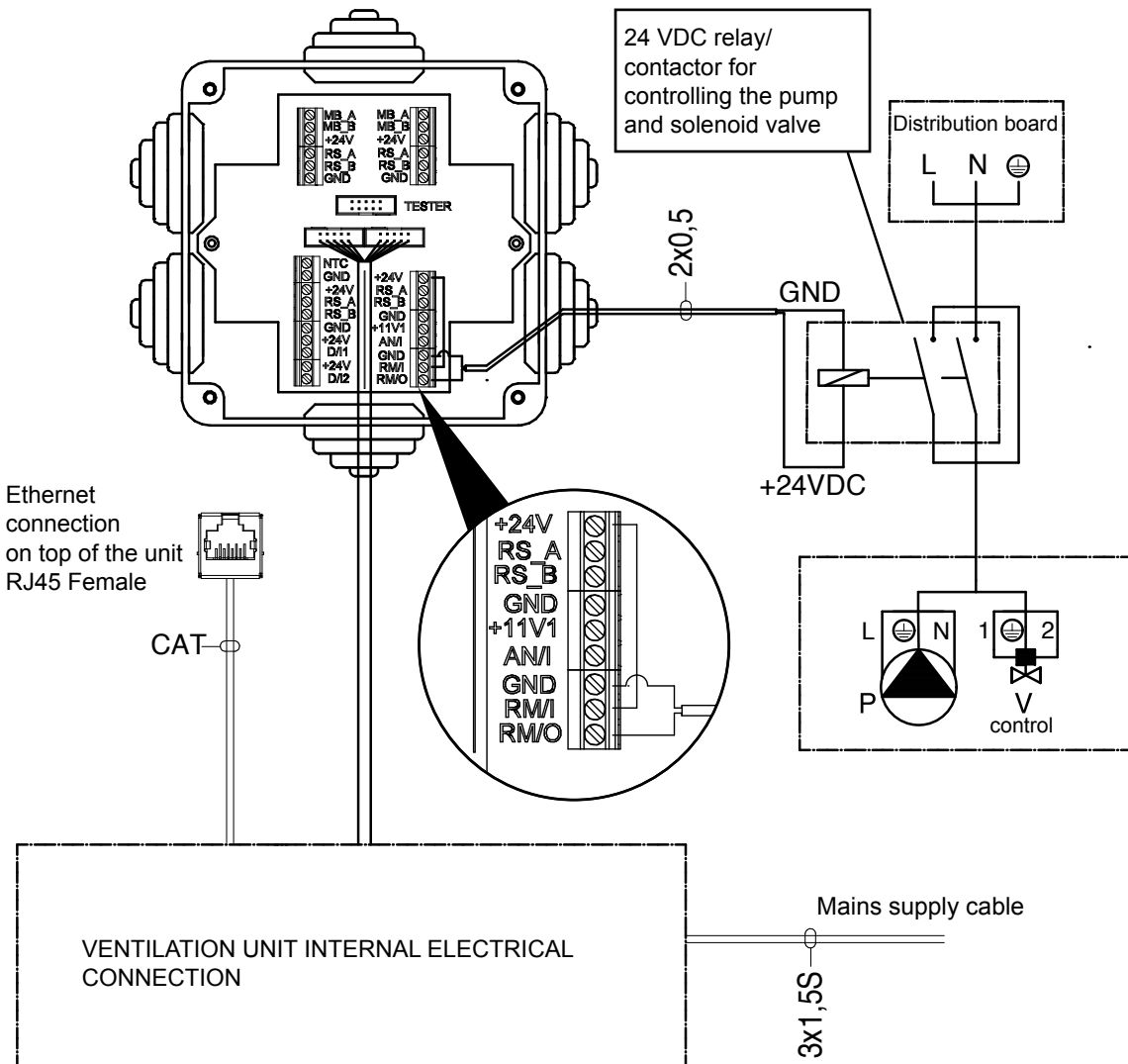

+24V	+24V direct current voltage (DC)
GND	Digital and analog ground potential
RS_A	Local hardware Modbus A signal
RS_B	Local hardware Modbus B signal
11V1	11.1 V operating voltage
AN/I	AN/I = Analog input 0-10VDC
RM/I	24V relay input
RM/O	24V relay output
P	Circulation pump
V	Solenoid valve

Adroit® DV245 (Integral CO₂ Sensor)

DUCT RADIATOR OPERATION CHART

In the outdoor air duct

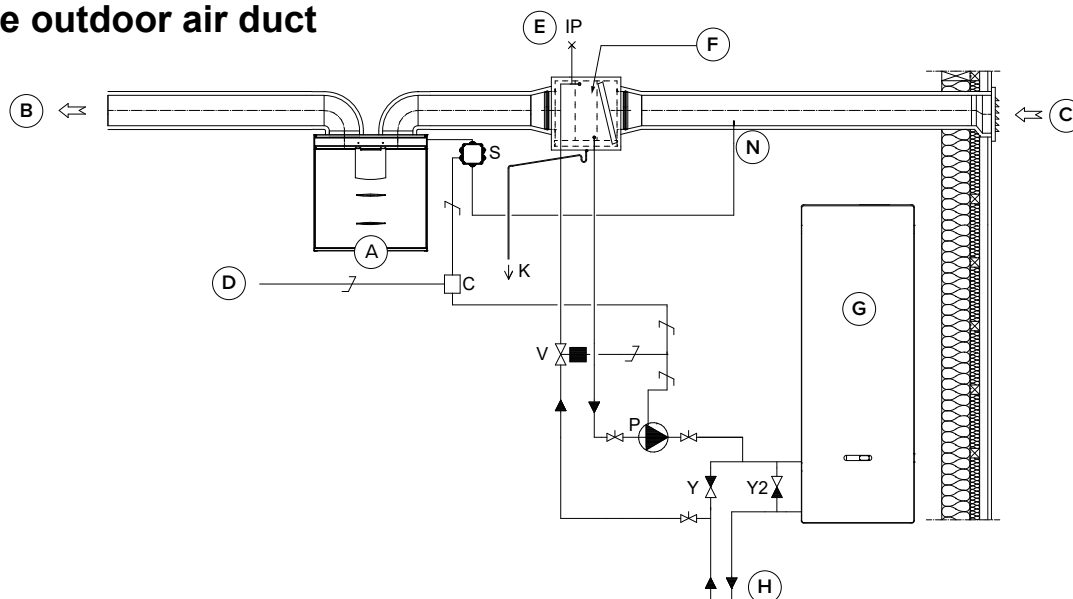

In the supply air duct

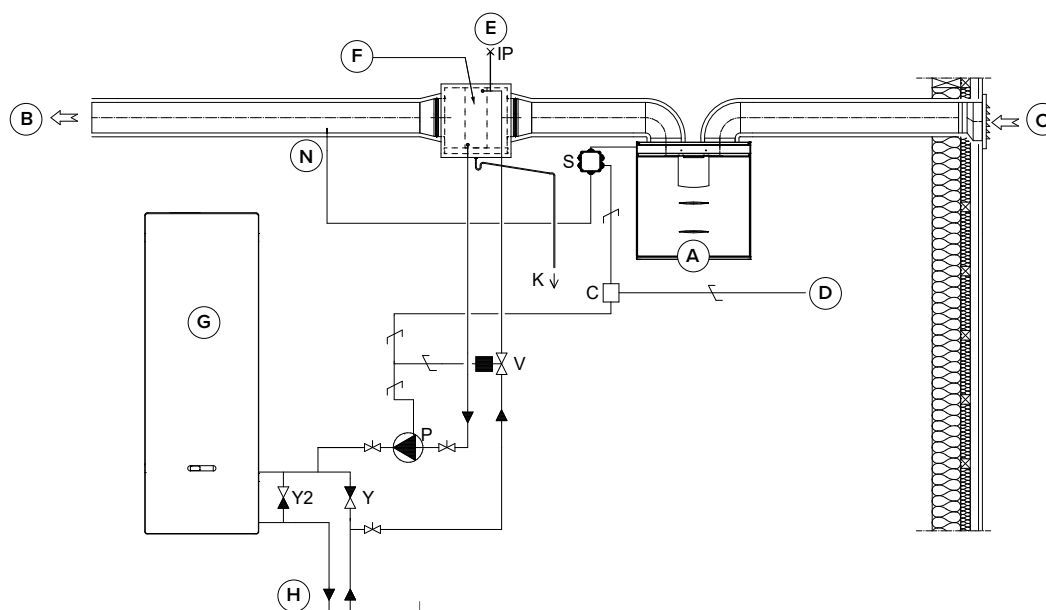

A	Ventilation unit
B	Supply air
C	Outdoor air
D	Feed from the distribution board
E	Air extraction
F	Duct radiator (reverse connection)
G	Heat pump
H	Heat collection circuit
N	External NTC sensor

P	Circulation pump. Not included in the delivery. The pump should be suited to pumping liquid colder than the surrounding air, due to risk of condensation (for example, Grundfos Magna 1 25-80).
V	Solenoid valve. Not included in the delivery. The valve that is chosen must be compatible with the heat collection circuit fluid (for example, ELV05006, Stig Wahlström).
K	Condensing water tube. Not included in the delivery.
IP	De-aerator. Not included in the delivery.
S	External electrical junction box for the Adroit units
N	External NTC sensor for Adroit ventilation units
C	24 VDC relay/contacter for controlling the pump and the solenoid valve. Not included in the delivery. (For example, ABB CR-P024DC2)
Y	One-way valve. Not included in the delivery.
Y2	One-way valve. Not included in the delivery. The pressure loss must be less than the pressure loss of the heat pump.

Adroit® DV245

(Integral CO₂ Sensor)

HEATING AND COOLING RADIATOR OPERATION CHARTS

OPERATION AND SAMPLE CONNECTION

Always follow first and foremost the connection diagram provided by the HVAC designer or heat pump manufacturer. The accompanying figure shows an example of the arrangement for connecting the heating/cooling radiator unit to the heat collection circuit.

Connect the radiator output pipe to the heat collection circuit return pipe. Direct the fluid returning from the radiator unit to the heat collection circuit return pipe. If you know that there is a large loss of internal pressure inside the heat pump, the heat pump should be bypassed. If this is done, the fluid circuit will come into operation when the heat pump comes to a halt. When this happens the pressure loss in the one-way bypass valve Y2 must be lower than the pressure loss in the heat pump.

The duct radiator can be installed in both the supply air duct and the outdoor air duct. If the radiator is installed in the outdoor air duct, it can be used for both preheating and cooling or for preheating or cooling alone.

The duct radiator can be set to function either automatically or manually.

Automatic - In summer, the supply air temperature will be maintained at the level specified in the temperature setting. In winter, the duct radiator will turn on, when the outdoor temperature falls below the winter setting.

Manual - In summer, the duct radiator will turn on when the outdoor temperature rises above the summer setting. In winter, the duct radiator will turn on when the outdoor temperature falls below the winter setting.

To prevent the risk of condensation in the supply air duct, you can set the adjustment of the supply air limit to automatic or manual.

Automatic - The supply air limit is adjusted automatically based on the dew point of the extract air. When the supply air temperature falls too low, the duct radiator will turn off.

Manual - The supply air limit can be set manually. When the supply air temperature falls down to the set value, the duct radiator will turn off.

If an external sensor is in use, it is selected from the settings of the external sensor whether it is used to control the outdoor air duct radiator or the supply air duct radiator.



NOTE

If the duct radiator is used in the supply air duct, it can only be used for cooling.



NOTE

When used to control the outdoor air duct radiator, the external NTC sensor is installed in the outdoor air duct before the radiator. When used to control the supply air duct radiator, the external NTC sensor is installed after the radiator.



NOTE: HEATING

The pump starts when the outdoor air temperature drops below the winter limit value set at the factory (-5 °C).



NOTE: COOLING

The value set for the supply air temperature of the active profile (e.g. At home) controls the startup of the pump. The pump starts when the supply air setting is below the temperature of the supply air that is blown into the apartment.



NOTE

Due to the risk of humidity damage, in a duct that has not been insulated for condensation the supply air temperature must not fall below 16 ... 20 °C.



NOTE

When selecting the relay, take account of the maximum allowed combined power supply (6W) of the circuit card in the external connection box, if the relay power is obtained from the circuit board +24V connector.

Adroit® DV245 (Integral CO₂ Sensor)

EXPLODED VIEW AND PARTS LIST

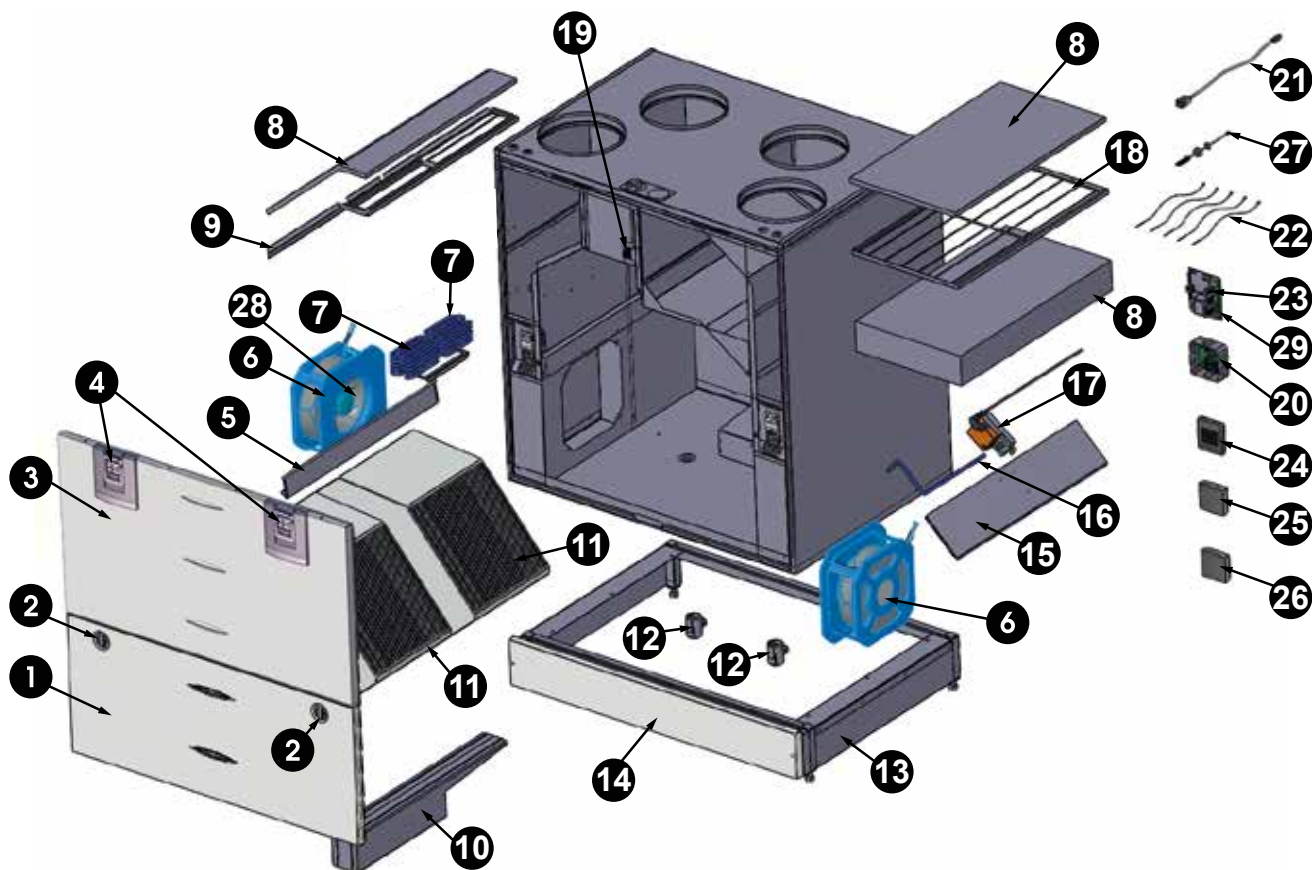

NO.	DESCRIPTION	PART NO.	NO.	DESCRIPTION	PART NO.	NO.	DESCRIPTION	PART NO.
1	Door assembly lower part	60000200	11	HR cell	60000266	21	RJ45 extension cable	60000209
2	Wing nut	60000261	12	Condensation drain kit	60000250	22	NTC sensor kit	60000204
3	Door assembly upper part	60000199	13	Base assembly	60000268	23	Glass tube fuse 5x20, 80mA, slow	60000231
4	Door latch assembly	60000224	14	Front panel of the base	60000269	24	Adroit Digital Controller (optional)	90000610
5	Upper sealing strip of the HR cell	60000263	15	Bypass damper	60000270	25	Adroit Humidity Transmitter (optional)	90000612
6	Fan assembly	60000218	16	Bypass arm	60000271	26	Adroit CO ₂ Transmitter (optional)	90000613
7	Post/Additional heater 1500W (optional)	60000223	17	Bypass damper motor	60000207	27	Internal humidity and carbon dioxide sensor	60000591
8	Filter set: 2x ISO Coarse > 75% (G4), ISO ePM1 (F7)	90000611	18	Outdoor air ISO Coarse > 75% (G4) filter stand	60000272	28	Supply air fan attenuation grid	60000274
9	Extract air ISO Coarse > 75% (G4) filter stand	60000264	19	Safety switch	60000135	29	Adroit motherboard	60000581
10	Lower support for HR cell	60000265	20	Connection box	60000208			



CE DECLARATION OF CONFORMITY

Airflow Developments Ltd, herewith declare that the air movement equipment designated below, on the basis of its design and construction in the form brought onto the market by us in accordance with the relevant safety and health requirements of the EC directive on Low Voltage.

Designation of Equipment: Mechanical Ventilation with Heat Recovery

Relevant EC council directives:

2014/35/EU	Low Voltage Directive
2014/30/EU	Electromagnetic Compatibility (EMC) Directive
2011/65/EU	Restriction on the use of hazardous substances (RoHS) Directive
2006/42/EU	Machinery Directive

Applied Harmonised standards:

EN ISO 12100-1:2003+A1:2009	Safety of machinery. General principles for design. Risk assessment and risk reduction
BS EN 61000-6-4:2007+A1:2011	Electromagnetic compatibility (EMC). Generic standards. Emission standard for industrial environments
BS EN 60335-1:2012+A11:2014	Household and similar electrical appliances. Safety. General requirements
BS EN ISO 13732-1:2008	Ergonomics of the thermal environment. Methods for the assessment of human responses to contact with surfaces. Hot surfaces
BS EN ISO 3746:2010	Acoustics. Determination of sound power levels and sound energy levels of noise sources using sound pressure. Survey method using an enveloping measurement surface over a reflecting plane

Applied National Standards and Technical Specs. In Particular Basis of self-attestation:

Quality Assurance	BS EN ISO 9001/2015 – Cert no – FM 00152
Environmental Assurance	BE EN ISO 14001/2015 – Cert No – EMS 569454

Any alterations or modifications made to the equipment, without prior consultation with Airflow Developments Ltd, invalidates this declaration.

Name: Alan Siggins

Date: 10/06/2019
Position: Managing Director

Airflow Developments Limited
Aidelle House, Lancaster Road, Cressex Business Park
High Wycombe, Buckinghamshire. HP12 3QP, U.K.
T: +44 (0)1494 425252
E: info@airflow.com W: airflow.com

UKCA CERTIFICATE OF CONFORMITY

UKCA DECLARATION OF CONFORMITY

Airflow Developments Ltd, herewith declare that the air movement equipment designated below, on the basis of its design and construction in the form brought onto the market by us in accordance with the relevant safety and health requirements of the EC directive on Low Voltage.

Designation of Equipment: Mechanical Ventilation with Heat Recovery
Relevant EC council directives:

2016 No.1101	The Electrical Equipment (Safety) Regulations 2016
2016 No.1091	The Electromagnetic Compatibility Regulations 2016
2012 No.3032	The Restriction of the Use of Certain Hazardous Substances in Electrical and Electronic Equipment Regulations 2012
2008 No.1597	The Supply of Machinery (Safety) Regulations 2008

Applied Harmonised standards:

EN 12100-1:2003+A1:2009	Safety of machinery. General principles for design. Risk assessment and risk reduction
BS 61000-6-4:2007+A1:2011	Electromagnetic compatibility (EMC). Generic standards. Emission standard for industrial environments
BS 60335-1:2012+A11:2014	Household and similar electrical appliances. Safety. General requirements
BS ISO 13732-1:2008	Ergonomics of the thermal environment. Methods for the assessment of human responses to contact with surfaces. Hot surfaces
BS ISO 3746:2010	Acoustics. Determination of sound power levels and sound energy levels of noise sources using sound pressure. Survey method using an enveloping measurement surface over a reflecting plane

Applied National Standards and Technical Specs. In Particular Basis of self-attestation:

Quality Assurance	BS ISO 9001/2015 – Cert no – FM 00152
Environmental Assurance	BS ISO 14001/2015 – Cert No – EMS 569454

Any alterations or modifications made to the equipment, without prior consultation with Airflow Developments Ltd, invalidates this declaration.

Name: Alan Siggins

Date: 10/06/2019

Position: Managing Director

Airflow Developments Limited
 Aidelle House, Lancaster Road, Cressex Business Park
 High Wycombe, Buckinghamshire. HP12 3QP, U.K.
 T: +44 (0)1494 425252
 E: info@airflow.com W: airflow.com



Aidelle House, Lancaster Road, Cressex Business Park,
High Wycombe, Buckinghamshire,
HP12 3QP, United Kingdom

Product Security and Telecommunications Infrastructure Statement of Compliance

Airflow Developments Ltd, herewith declare that the air movement equipment designated below, on the basis of its design and construction in the form brought onto the market by us in accordance with the relevant requirements of the UK Product Security and Telecommunications Infrastructure (Product Security) regime.

Designation of Equipment: Airflow Ventilation Equipment

Series / Type:

- Adroit with Cloud Connectivity functionality Series
- Entro-V with Modbus Series
- Duplexvent AHU Units Series (Multi, Multi V, Multi N Rooftop, Multi Eco, Multi Eco V, Multi Eco N Rooftop, Rotary, Rotary N Rooftop, Flexi, DUPLEXhome PS, DUPLEXhome PT, DUPLEXbase PS, DUPLEXbase PT) with RD5 or RD6 Control System
- iCONsmart

Applied Legislations:

PSTI Act 2022 Part 1 of the Product Security and Telecommunications Infrastructure

Security Requirements for Relevant Connectable Products Regulations 2023 The Product Security and Telecommunications Infrastructure

The requirements are based on three of the original guidelines in the 2018 Code of Practice, and provisions in ETSI EN 303 645, on a statutory footing.

The minimum time that Airflow provides security updates for is 2 years from the date of installation/commissioning.

Information on how to report security issues related to the products listed above: please contact Airflow on the telephone number shown below and describe the security issues encountered.

Any alterations or modifications made to the equipment, without prior consultation with Airflow Developments Ltd, invalidates this declaration.

Signed:

Date: 28/03/2024

Name: Alan Siggins

Position: Managing Director

Telephone: (Int +44) (UK 0) 1494 525252; Fax: (Int +44) (UK 0) 1494 461073
E-mail: info@airflow.com; Website: www.airflow.com

Form No:- 080
Issue:- 002
Date Revised:- 09/06/2015



Adroit® DV245 (Integral CO₂ Sensor)

Extensive

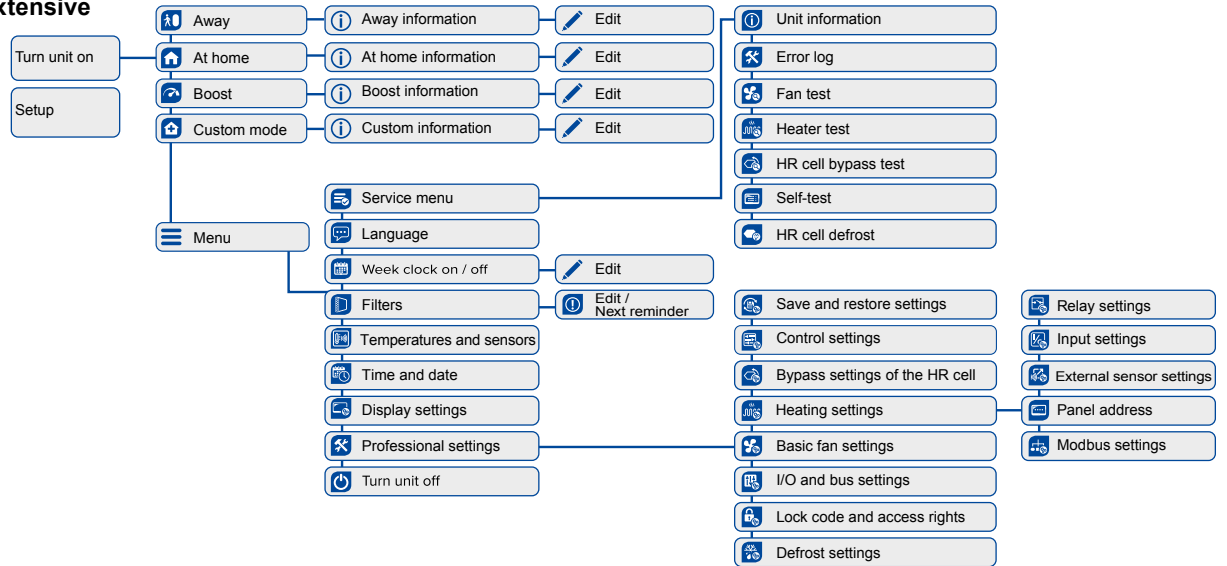

Normal

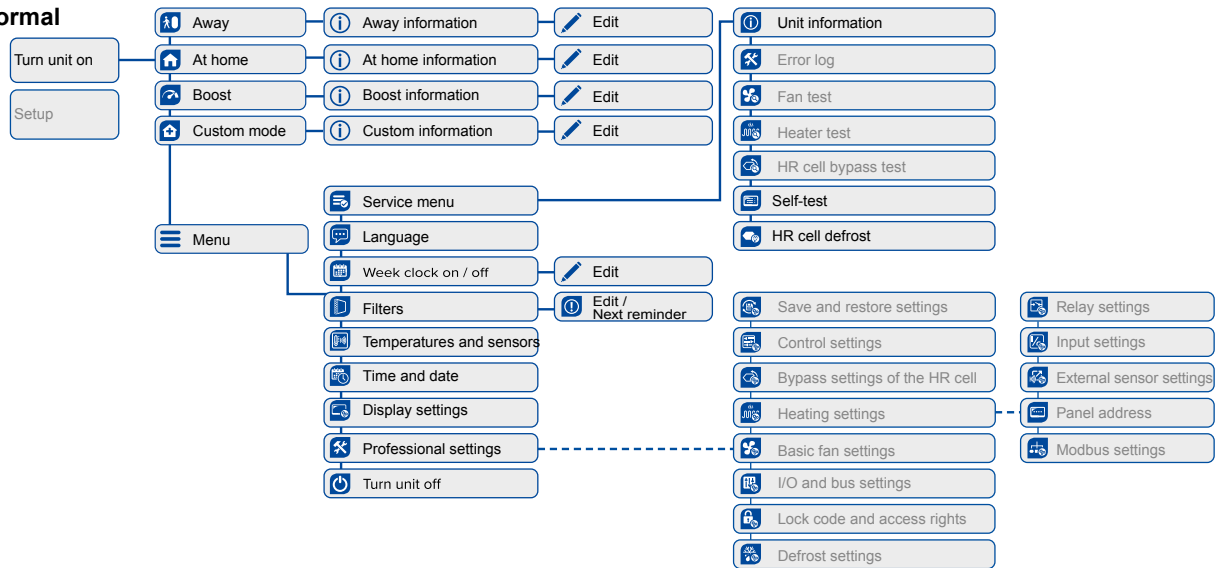

Adroit[®] DV245 (Integral CO₂ Sensor)

USER LEVEL DIAGRAMS

Limited

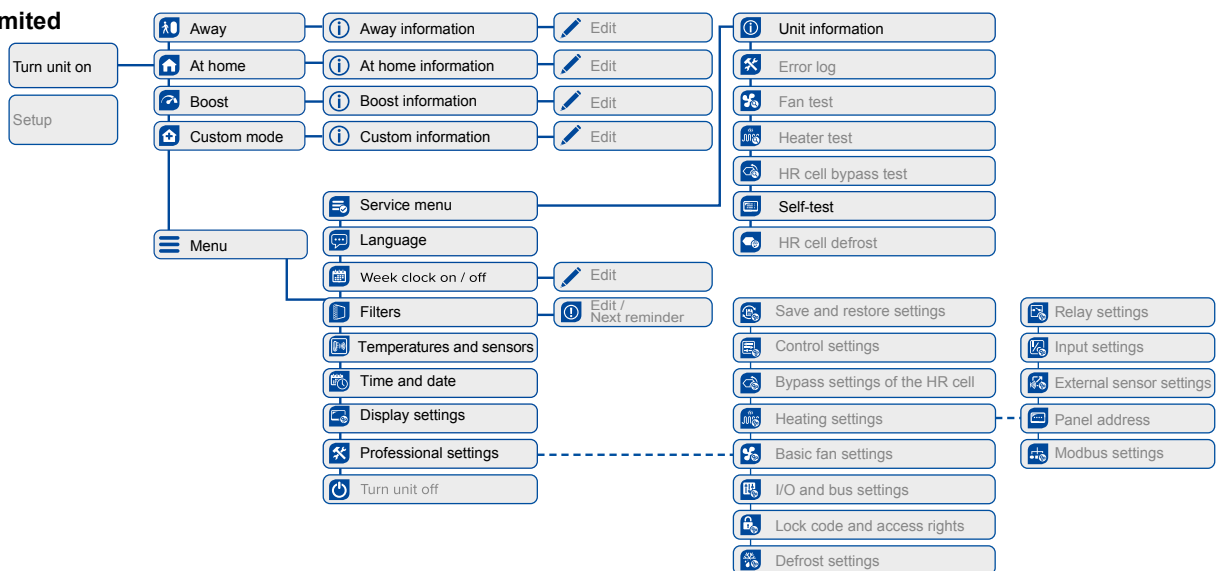

Adroit® DV245

(Integral CO₂ Sensor)

COMMISSIONING THE SYSTEM

The Building Regulations 2010, Statutory Instrument Part 9, paragraph 42, imposes a requirement that testing and reporting of mechanical ventilation performance is conducted in accordance with an approved procedure.

Compliance with this requirement by an assessed and registered “Competent Person” should follow a “Best Practice” process and adopt air flow measurement, Method A - The Unconditional Method - using a suitable UKAS certified measuring instrument. Generically referred to as a “Zero Pressure Air Flow Meter” or “Powered Flow Meter”.

Further information on this method is detailed in NHBC Building Regulations Guidance Note G272a 10/13 and BSRIA “A Guide to Measuring Air Flow Rates” document BG46/2015

WARRANTY

Applicable to units installed and used within the United Kingdom. Airflow Developments Ltd guarantees the DV245 Adroit unit for 5 YEARS from date of purchase against faulty material or workmanship. Motors are only covered for 1 YEAR from date of purchase against faulty material or workmanship.

In the event of any defective parts being found, Airflow Developments Ltd reserve the right to repair, or at our discretion, replace without charge provided that the unit:

- Has been installed and used in accordance with the fitting and wiring instructions supplied with each unit.
- Has not been connected to an unsuitable electrical supply.
- Has not been subjected to misuse, neglect or damage.
- Has not been modified or repaired by any person not authorised by Airflow Developments Ltd.
- Has been installed in accordance with latest Building Regulations and IEEE wiring regulations by a recognised competent installer.

Airflow Developments Ltd shall not be liable for any loss, injury or other consequential damage, in the event of a failure of the equipment or arising from, or in connection with the equipment, excepting only that nothing in this condition shall be construed as to exclude or restrict liability or negligence.

This warranty does not in any way affect any statutory or other consumer rights.



Call: 01494 525252

Visit: airflow.com



Airflow Developments Limited
Aidelle House, Lancaster Road,
Cressex Business Park,
High Wycombe, Buckinghamshire,
United Kingdom, HP12 3QP

E-mail: info@airflow.com
Telephone: +44 (0) 1494 525252

airflow.com

© Airflow Developments Limited. Airflow Developments Limited reserve the right, in the interests of continuous development, to alter specifications without prior notice. All orders are accepted subject to our conditions of sale which are available on request



80000996 - Issue 5 07/24